



NET **X**PERT XG2

MANUAL

Version 1.7: March 29, 2021

CONTENTS

CONTENTS.....	2
INTRODUCTION	4
SAFETY INSTRUCTIONS.....	5
Voltage	5
DEVICE STRUCTURE	6
SCOPE OF DELIVERY	7
Standard NetXpert XG2.....	7
NetXpert XG2plus	7
OPERATION	7
On/Off	7
Automatic shutdown.....	8
Touchscreen	8
Icons	9
NetXpert XG2 Active Remote device	10
REGISTER DEVICE.....	11
SYSTEM SETTINGS.....	12
Wi-Fi.....	15
Language	17
Energy	18
 More Options.....	19
itnetworks.softing.com/xgfirmware	21
CABLE TEST.....	25
Set Reference	37
Set Reference Copper	37
Set Reference Fiber	38
NETWORK TESTS.....	40
Link Status	41
DHCP	41
Discovery.....	42
Traceroute.....	45
LLDP/CDP.....	46
VLAN	47
TOOLS.....	48
 Wiremap & Margin (Copper).....	49
Port Discovery (Copper).....	50
BERT test (Copper).....	51



Individual BERT test (Fiber Optic).....	54
Microscope (Fiber Optic).....	55
LiveLight (Fiber Optic).....	56
FILE MANAGEMENT.....	59
MAINTENANCE.....	60
RJ45 SOCKET.....	60
BATTERY.....	60
Note:.....	60
CLEANING.....	60
STORAGE.....	60
SPECIFICATIONS.....	61
Permissible humidity.....	61
Safety compliance.....	61
FREQUENTLY ASKED QUESTIONS.....	62
Q Why does the NetXpert XG2 show the cable length in red and report that the cable test has failed?	62
Q What is a TST file?.....	62
Q How do I get a firmware update for my NetXpert XG2?	62
Q Why do I not get a DHCP result in the link status test or network test?	62
Q How many cable tests can the NetXpert XG2 store?.....	62
Q Does the NetXpert recognize XG PoE (Power over Ethernet)?	63
Q Why is the length wrong and all my outlets show split-pair errors?.....	63
Q Why is the length wrong and all my outlets show split-pair errors?.....	63
Q What do the terms miswire, open circuit and short circuit mean?	63
Q What is the SNR margin?	63
CUSTOMER SERVICE.....	64
For technical information, see.....	64
WARRANTY STATEMENT.....	65
RETURN ADDRESS:.....	65

INTRODUCTION

The NetXpert XG2 cable qualifier is a complete solution for network cabling tests. It quickly and easily tests and documents whether a cabling link is suitable for operation of up to 10 Gigabit Ethernet in accordance with IEEE 802.3. To do this, the NetXpert XG2 checks for errors in the cabling as well as the signal-to-noise ratio and data transmission capability of Ethernet network cabling up to 10Gbit/s. This ensures the cabling is able to provide the required data transmission speeds for the devices connected to the network.



To qualify the Ethernet transmission performance of copper cabling links, the handy NetXpert XG2 calculates the signal-to-noise ratio (SNR) to determine the signal-quality, which may be particularly impacted by high speed data transfers, and performs bit error rate tests (BERT). Data packets with defined data rates are sent over the cabling link and checked for errors at the maximum link rate. The NetXpert XG2 also performs evaluations of the delay skew. These provide information about differences in the signal propagation delay of the individual wire pairs. With continuity testing, the NetXpert XG2 checks for interruptions, short circuits, swaps, split-pair errors and high-impedance errors. The NetXpert XG2 determines the exact distance to points of error and the entire cable length.

It is possible to qualify the fiber optic cables with the NetXpert XG2 Plus Kit as well. The main parameter for qualifying the fiber optic cables is BERT. As with the copper test, packets are sent at defined data rates to qualify fiber optic cables. In addition, there are optional parameters that do not have any effect on the qualification result but warn the user of possible errors. If the parameters Loss & Length are activated, the loss value is tested via SFP modules and displayed on the screen with a pass/fail result. The length is also determined as another parameter and included in the report. Another optional parameter is the testing of the connector end faces against IEC 61300-3-35 with a microscope. The results can then be included in the qualification report.

Equipped with several active test functions, the NetXpert XG2 checks the transmission capability of the networks in operation. The cable qualifier detects PoE (Power over Ethernet) voltage and uses a load measurement to determine if the voltage is delivering the required power. Port detection checks whether the corresponding data rate and duplex capability are available. The NetXpert XG2 connects to the network at up to 10Gbit/s and runs a ping test to verify connectivity to IP hosts. It detects network devices using the Cisco Discovery Protocol (CDP) or Link Layer Discovery Protocol (LLDP), provides VLAN detection, and tracks the route of data packets to a specific destination with trace route functionality. The test reports are stored in the device and can be transferred to the PC at any time.

SAFETY INSTRUCTIONS

To ensure safe operation of the NetXpert XG2, please carefully follow the instructions and observe the warning information in this manual. Failure to do so may damage the tester and cause serious injury or even death.

Symbol	Definition
	Warning/Caution: Risk of personal injury or equipment damage
Voltage	Warning: Risks could result in injury or death
	Conformite Europeenne. Complies with EU directives
	Information for disposal



Warning! To prevent fire and electric shock or personal injury:

- Do not open the housing; there are no parts in the device that can be serviced by the user.
- Do not modify the tester.
- Do not use the tester if damaged. Perform a visual inspection of the tester before each use.
- The tester is not suitable for connection to live telephone inputs, systems or devices, including ISDN devices. Applying voltage to these interfaces for longer periods can damage the tester.

The Li-ion battery may only be repaired by qualified personnel. Only original battery may be used for the tester.

Warning: This is a Class A product. In a domestic environment this product may cause radio interference in which case the user may be required to take adequate measures.

DEVICE STRUCTURE

Main device



Active Remote

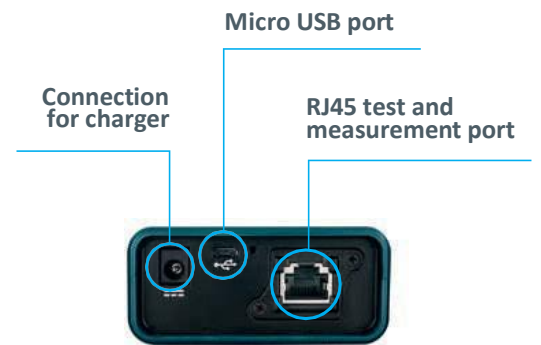
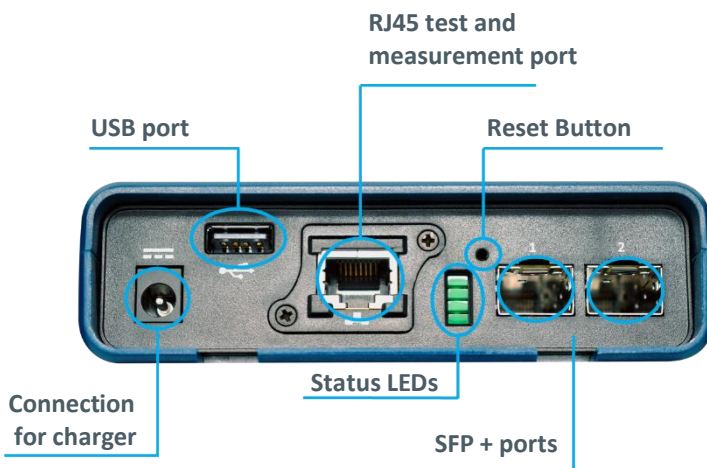

SCOPE OF DELIVERY

Standard NetXpert XG2

- 1 NetXpert XG2 main device
- 1 NetXpert XG2 Active Remote end device
- 2 plug-in power supplies
- 2 test cables
- 1 micro USB adapter
- 1 quick reference guide
- 1 carrying case



Figure 1 - NetXpert XG2 with Active Remote

NetXpert XG2plus

- like standard delivery
- + 1 additional NetXpert XG2 main device
- + 1 additional power supply unit
- + 4 LC/LC duplex patchcords (Multimode OM4 and Singlemode OS2)







Figure 2 - NetXpert XG2plus with two main devices for fiber qualification and one active remote for copper qualification

OPERATION

NetXpert XG2 main device

On/Off

- The NetXpert XG2 is turned on by pressing the On/Off button. The button indicates the operating status using light signals:

 OFF	 GREEN LIGHT (STEADY)	 GREEN LIGHT (FLASHING)	 RED LIGHT (FLASHING)	 RED LIGHT (STEADY)
<p>The NetXpert XG2 is switched off</p>	<p>The NetXpert XG2 is running on battery power and is sufficiently charged</p>	<p>The NetXpert XG2 is charging, power supply plugged in</p>	<p>The NetXpert XG2 is switched on and the battery charge is below 20%</p>	<p>The NetXpert XG2 is switched on, power supply plugged in. Device is not charging due to high internal temperature to save batteries {both fans are running, charging starts automatically when temperature returns to normal}</p>

- Briefly pressing the On/Off button puts the NetXpert XG2 to sleep.
- Holding down the On/Off button switches off the NetXpert XG2.

Automatic shutdown

The NetXpert XG2 automatically goes to sleep to conserve battery power if there is no input or activity on the device - see chapter *Energy* for automatic shutdown of the display and the device.

Touchscreen

The NetXpert XG2 utilizes its large touchscreen for operation. The only hard button is the on/off power button.



Figure 3 - Home screen

When an input field is selected, a keyboard appears at the bottom of the screen to make the necessary entries. The type of keyboard depends on the input field.

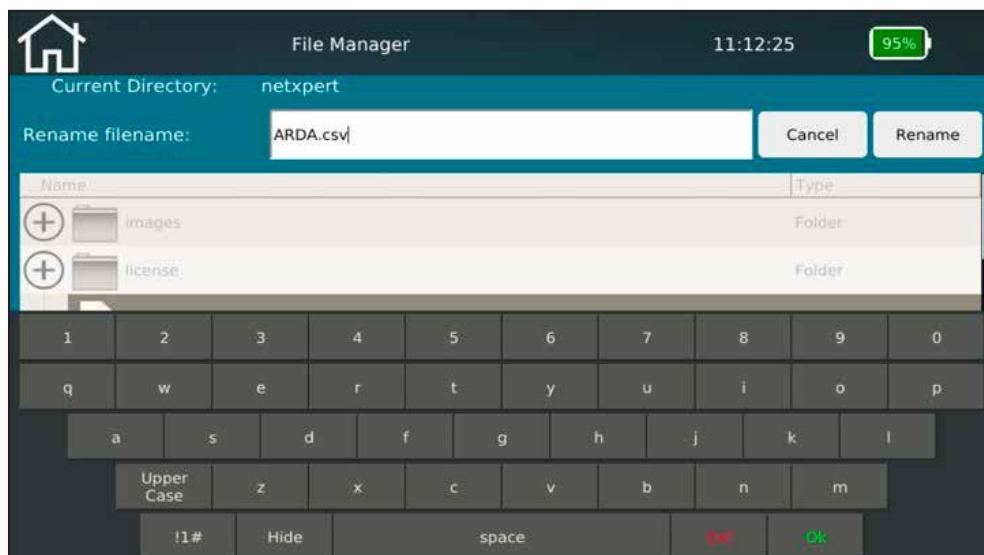

Figure 4 - Keyboard displayed after activating a text box

Icons



Tapping on this icon will hide or display the menu on the left



Tapping on this icon will take you back to the home screen



Shows in which mode the device is and serves for switching



Shows the strength of the WLAN connection



The battery indicator shows the level of the battery



This icon in the battery display indicates that the NetXpert XG2 is charged via an external power supply



By clicking on this, icon you can reach the cable test screen



By clicking on this, icon you can reach the network test screen



By clicking on this, icon you reach the file menu



By clicking on this, icon you reach the tools menu



By clicking on this, icon you reach the preferences menu



By clicking on this, icon you can reach the remote menu



By clicking on this icon, you can register your device and enable reporting feature



Displayed results are exported to a CSV file



Displayed results are exported to a PDF file

INTRODUCTION

NetXpert XG2 Active Remote device

- Pressing the Status button displays the charge level of the Active Remote battery and the last test result.
- Pressing the Test button starts a qualification test from the Active Remote.



Figure 5 – NetXpert XG2 Copper Remote Unit



REGISTER DEVICE

Tap on the register device icon on the home screen to start registering process of your NetXpert XG. The feature set of the product does not include reporting feature. However, user can activate reporting feature by registering the product free of charge anytime.

Product Registration

Serial 204901522

E-mail Address*

Date of Purchase

Vendor

Wi-Fi Settings Send

* Mandatory fields

Figure 6 – Product registration screen

Serial number of the device is taken automatically and cannot be changed by the user. E-mail address must be entered to complete registration. Date of purchase and vendor information can be entered optionally.

Product registration can be only done via W-Fi connection. Wi-Fi settings shortcut can be used to access to Wi-Fi settings screen to select an access point and establish an internet connection. Tapping on send button will send the information to Softing Server and activate reporting feature automatically.

User will then receive e-mails with MySofting login credentials. More information on the product like latest firmware, release notes, manuals can be found on <https://itnetworks.softing.com/my-softing/>.



SYSTEM SETTINGS

Tap on the settings icon on the home screen to configure the NetXpert XG2.



HW Config

In hardware configuration screen, preferred medium can be selected for a networking test as well as fiber optic cable test. It is also possible to find out detailed information of an SFP by simply inserting it in one of two SFP cages.

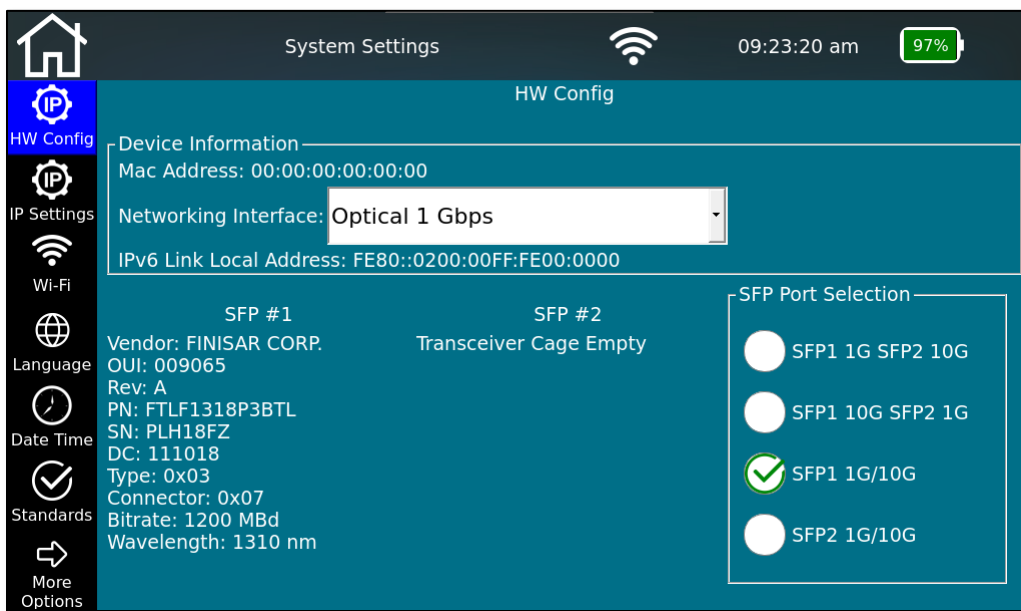

Figure 7 – HW Configuration

SFP Port Selection

As both SFP cages on the unit are capable of transmitting data on 1Gbit/s and 10 Gbit/s, it is necessary to configure the ports before running a fiber cable test or an active network test. It is sufficient to set the preferred combination once and NetXpert XG2 will remember it when running either passive cable test or an active network test.

Device Information

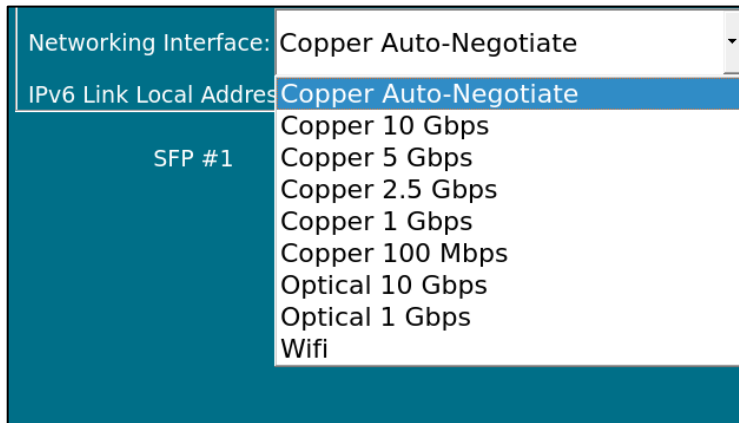

Figure 8 - Networking interface

The Interface Selection dropdown menu offers the choice of interface used for the active tests:

- RJ45 port for copper
 - Auto-negotiation or fixed speed
- "1Gbps" for fiber optic testing at 1 Gigabit Ethernet via optional SFP module
- "10Gbps" for fiber optic testing at 10 Gigabit Ethernet via optional SFP+ module {after this selection, the device boots into a special mode}
- "WiFi", connection to the network is established via WLAN. See next page *WiFi Scan* for settings

This window provides additional device information for incorporation into an active network:

- MAC address
- IPv6 link local address

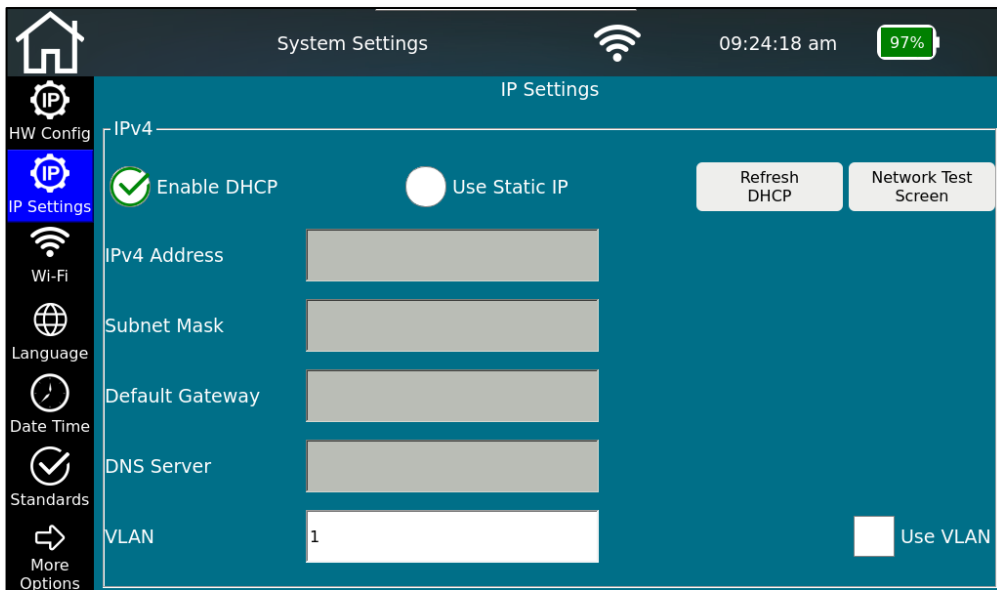

Figure 9 - IP specifications (DHCP)

In the NetXpert XG2's IP Setup, network tests can be configured so a DHCP or a fixed IP address can be used. The setting can also be made so that a DNS assigned by a DHCP server or a fixed DNS IP address is used.

Pressing **Network Test Screen** takes you directly to the operating menu of the active tests.

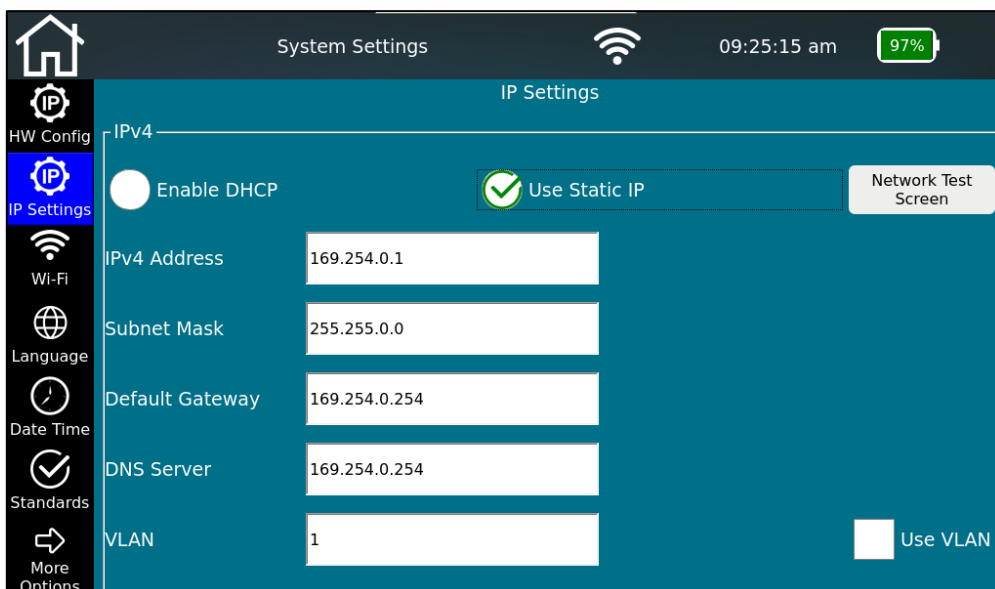

Figure 10 - IP specifications (Static IP)

 Wi-Fi

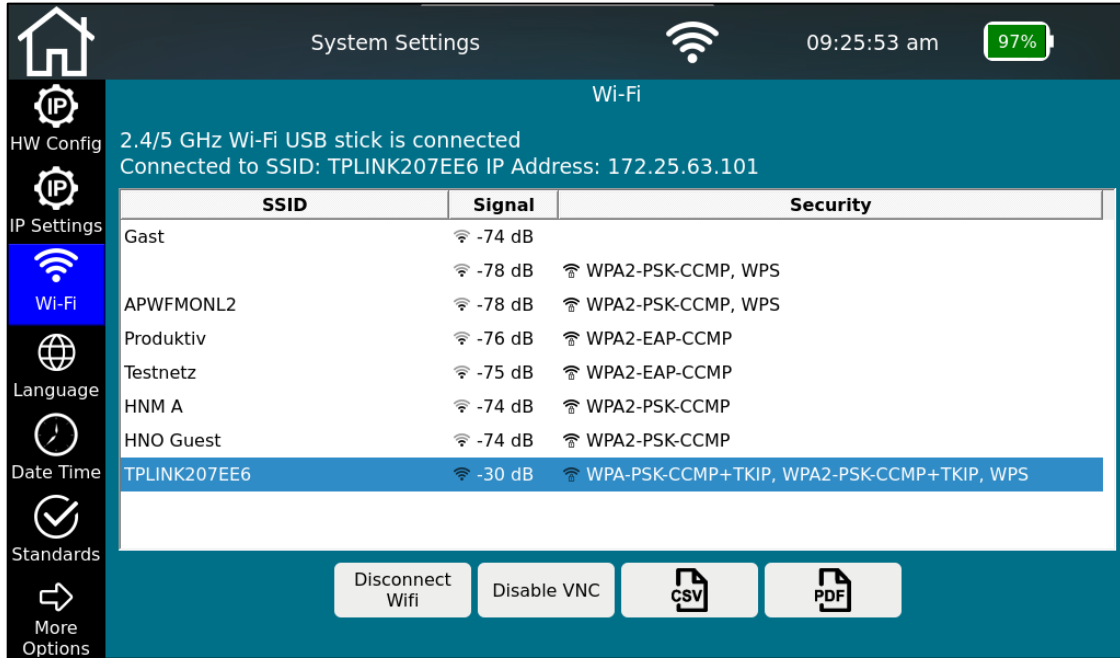

Figure 11 - Wi-Fi scan result

By selecting the Wi-Fi menu, a network scan automatically starts in the 2.4/5GHz band and it will display available SSIDs.

The following SSID information is displayed: The name of the network, its signal strength and encryption methods.



Figure 12 - Selection of the WiFi network and connection {entering the password}

To join a WiFi network, highlight an SSID, select “Select SSID” and enter the password (if required). Select the show password box to display the password being entered.

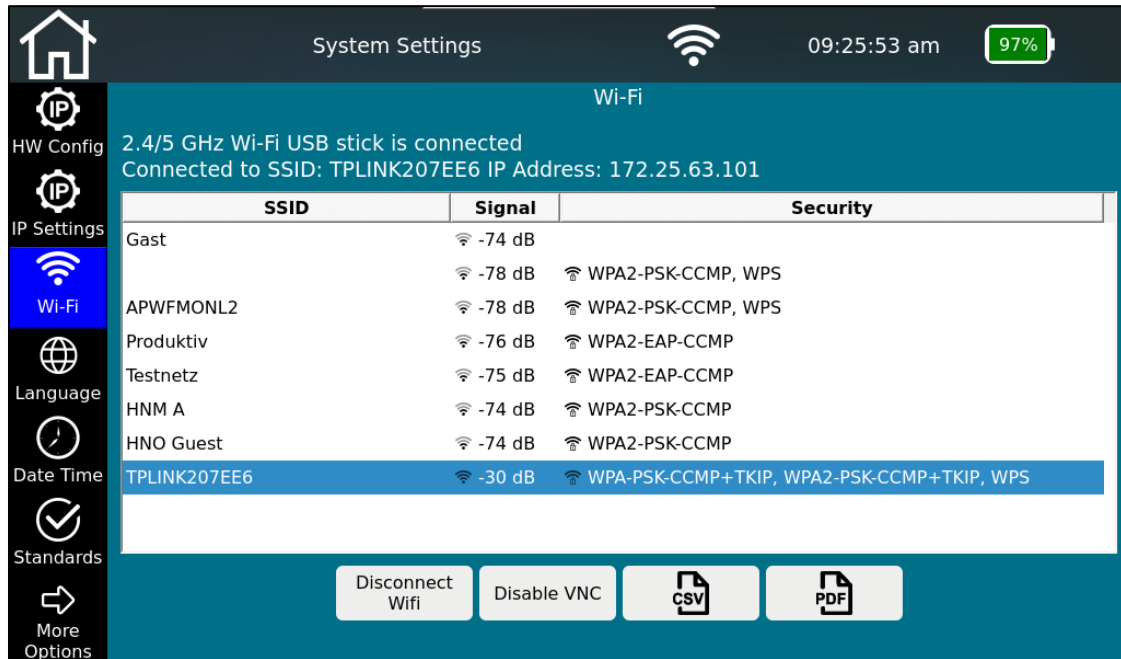

Figure 13 - Menu options after making a Wi-Fi connection

After the connection is established, the connection data {SSID name and IP address} is displayed and all active network tests are available. The WiFi icon will be displayed in the header for the duration of the WiFi connection. The selection as test interface is made in the **HW Config** menu.

VNC host functionality is available via the **Enable/Disable VNC** button. VNC can be used for remote control of device functions or as a screen display aid for presentations or to create screenshots.

Disconnect WiFi turns off the connection to the network and starts a new scan.

SSID, Signal and Security information can be generated into a csv and pdf report by tapping on the respective buttons.

**NetXpert XG Secure Edition comes with internal Wi-Fi feature disabled. In that case, if required, an external Wi-Fi USB stick can be purchased as an optional accessory and inserted into the unit. The status of used medium for Wi-Fi connection, will be shown at the top of the screen.*

Language

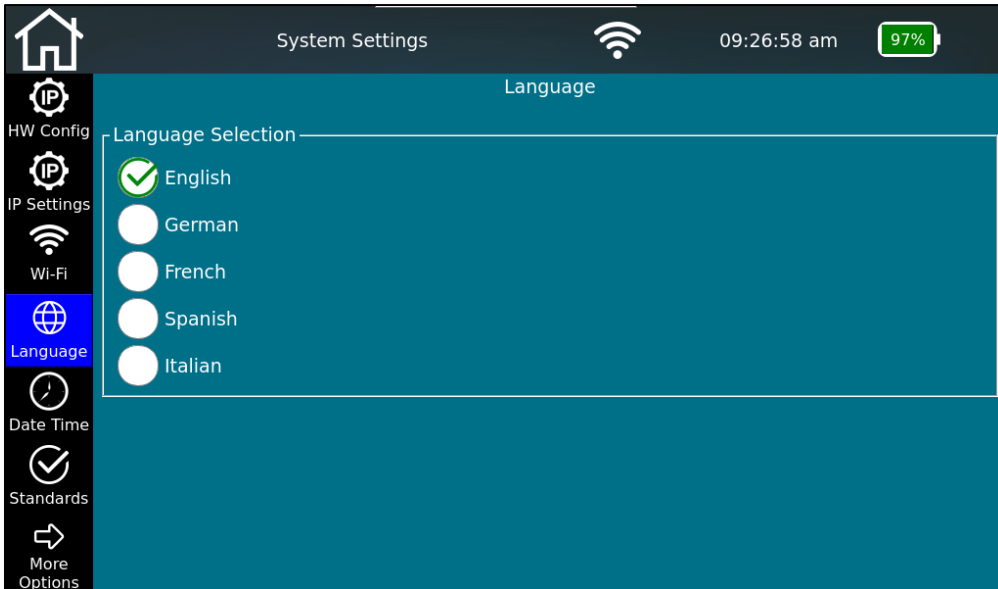

Figure 14 - Language setting

Select the desired language for the user interface.
Changing the language also changes the keyboards accordingly.

Date Time

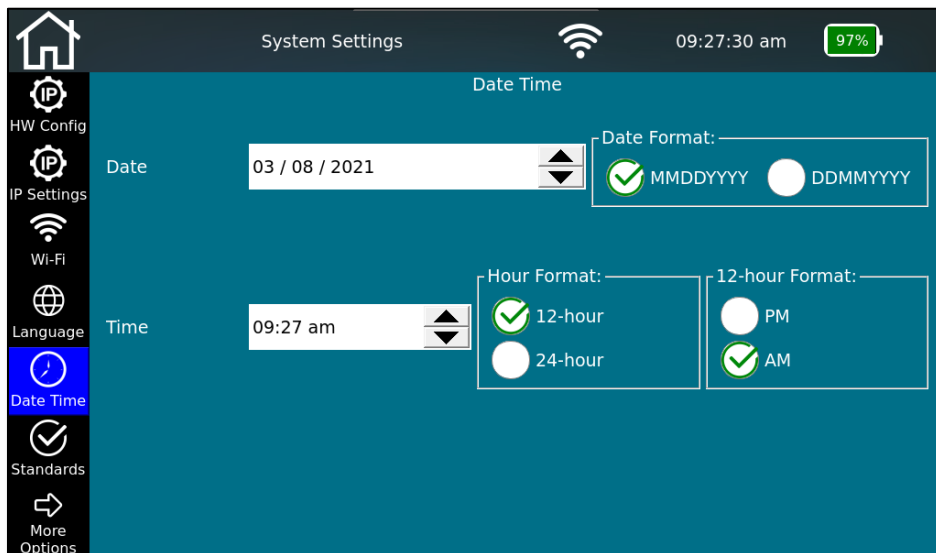

Figure 15 - Date and time

Set the current time and date. You can also set whether the time should be displayed in 12- or 24-hour format and the date in the usual formats. This date will be applied to the test protocols and should match the actual test date.

⚡ Energy

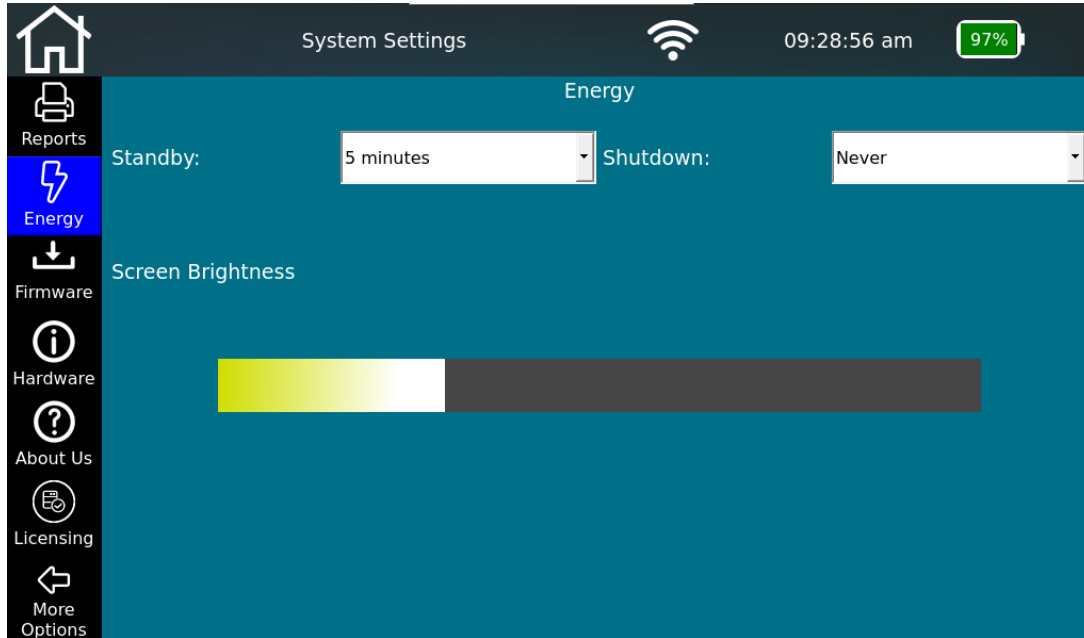

Figure 16 - Energy saving settings

To save energy and extend battery life, you can adjust the screen brightness and the time until standby/auto switch-off. To do so, move the brightness slider to the left/right or change the time until standby and auto switch-off when not in use.

Reactivation from standby is then possible at any time using the On/Off button or by tapping the screen of the NetXpert XG2.

Standards

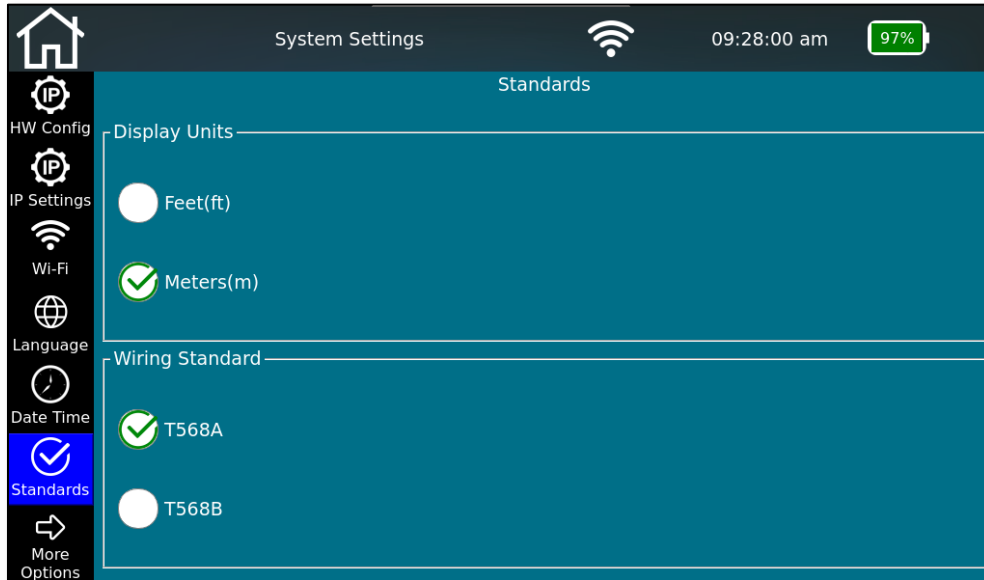

Figure 17 - Setting the units and cabling standards

In the Standards menu screen, you can choose whether to display the length in meters or feet. The NetXpert XG2 supports the two cabling standards. Select TIA568A or TIA568B. This affects the representations of the cabling image.

More Options

Pressing this button will take you to the second page of the *System Settings* screen.

Reports

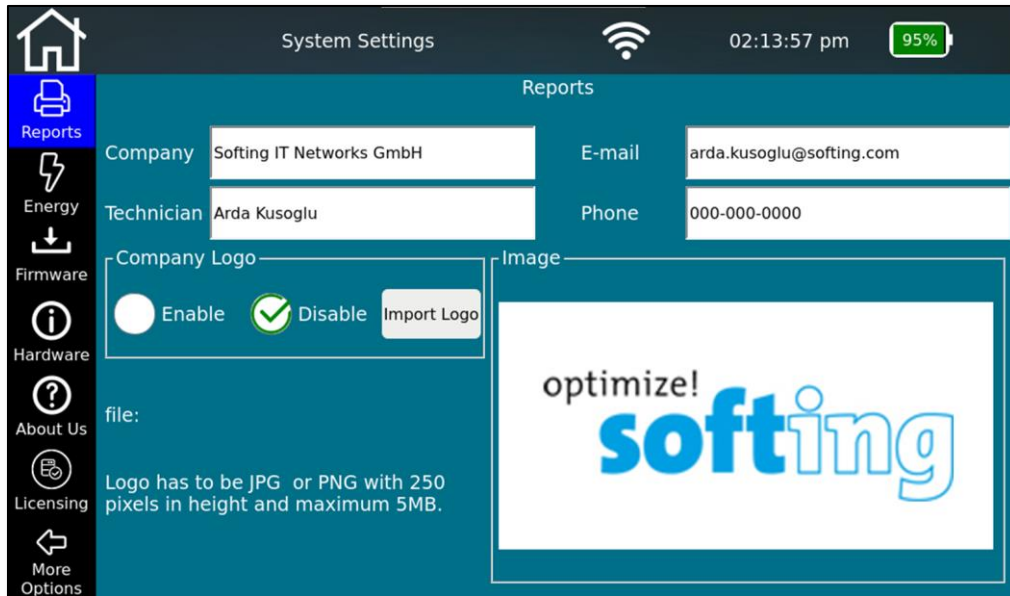

Figure 18 - Basic settings for test reports

In the reports menu screen you can personalize your reports, enter the name of your company, the technician name, your contact details and a company logo here.

To save a company logo, connect a USB stick with your company logo to the device and tap on **Import Logo**. This opens a file browser where you can navigate to your logo file on the USB stick and select the logo. Your logo will be displayed automatically in the lower right part of the screen. This is used to check whether the dimensions and quality of the logo meet the requirements.

The logo will be printed on your reports as a company logo as it is displayed here. Please note the possible formats and sizes.

Reporting feature is not part of standard set of features at the delivery. However, it can be activated registering the product on main screen.

↓ Firmware

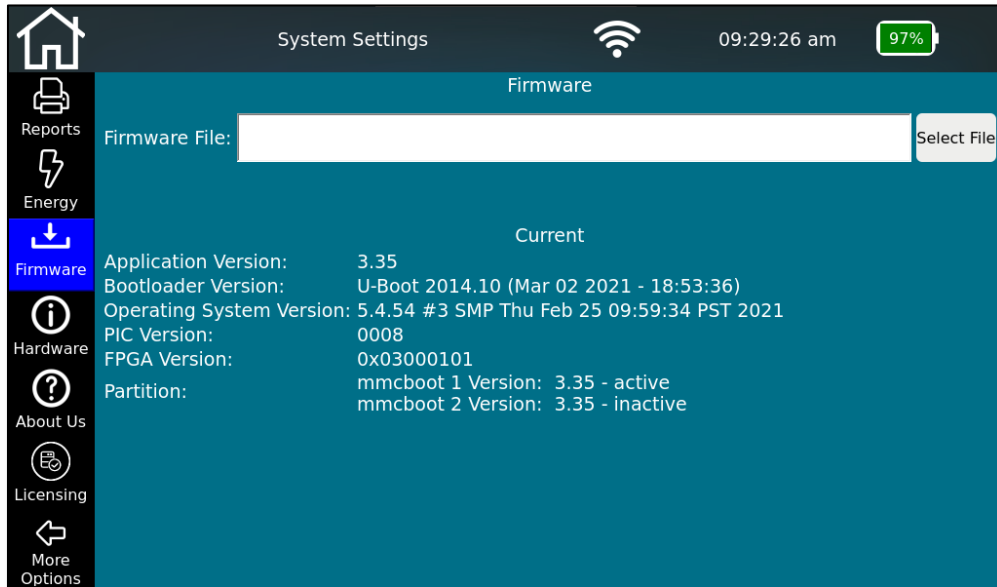

Figure 19 - Firmware management

The firmware menu screen provides information about the currently installed firmware version. You can also update the NetXpert XG2 firmware using this screen. Regular firmware updates are for troubleshooting purposes or contain simple free performance enhancements. They are freely available through the Softing website and are offered at regular intervals:

itnetworks.softing.com/xgfirmware

To install an update, visit the URL above and download the firmware file. Save the firmware file to a USB stick and connect it to the NetXpert XG2. From this menu screen, you can then select and install the update file. Follow the instructions on the screen of the device.

Hardware



Figure 20 - Hardware status

The hardware menu screen provides information about the installed hardware in the device, including the board revision and the serial number of the device. In addition, internal temperatures and battery charge level are displayed.

About Us

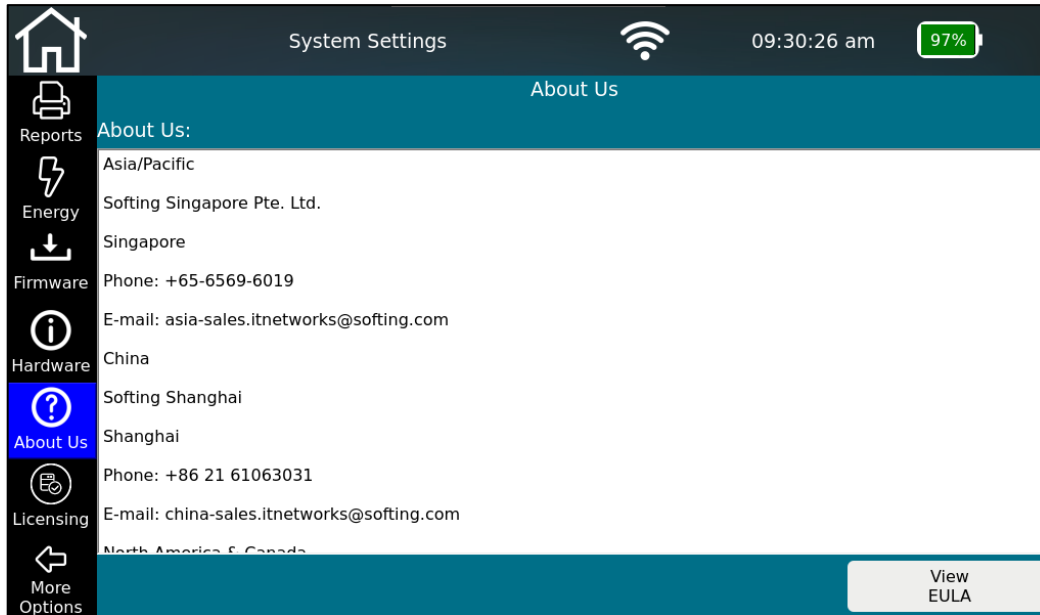

Figure 21 - Softing contact information

The About Us menu screen lists the worldwide contact information of Softing IT Networks in case you need product support or have other requests.

In addition, the EULA {End User License Agreement}, which appears when you first start the device, can be viewed again here.

Licensing

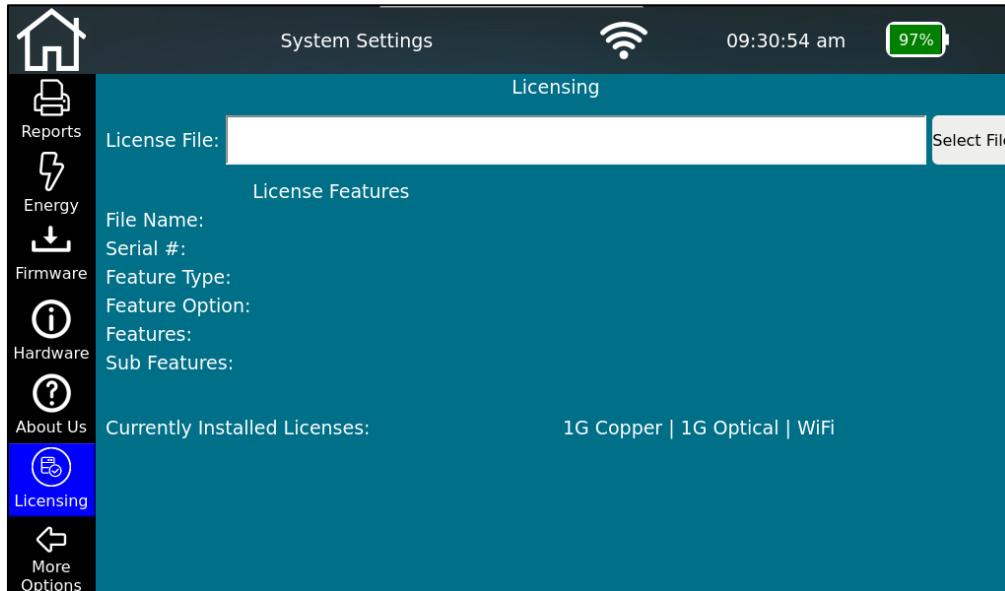

Figure 22 - License management

The license menu screen allows you to extend the functionality of your NetXpert XG2. There are currently three variants:

- NetXpert 1G - Qualification up to 1Gbit/s
- NetXpert 2.5/5G - Qualification up to 5Gbit/s
- NetXpert 10G - Qualification up to 10Gbit/s

To perform a license upgrade, you only need a corresponding number of so-called step-up licenses. It does not matter which license your NetXpert XG2 currently has. The purchase of a "step-up" license extends the functionality of the device by one step up.

Any installed licenses or the performance range are displayed in the bottom line of the screen.

Appropriate licenses can be obtained from the known sources for Softing IT Networks products.



CABLE TEST

Before performing a cable test, you must set the mode of the main unit according to the cable under test. You can do this in the upper left corner of the home screen. If you want to test copper cables, the main unit must be in Cu mode. If you want to test fiber optic cables, you have to set the main unit to the fiber optic mode. To change the modes, tap on the green slider. For fiber qualification, you have to set one of the two main devices into the remote mode by pressing the "remote" button on its start screen and selecting the data rate to be tested. The SFP module matching the desired test and the main device must be plugged into the remote device. After completion of the tests, the remote unit can be switched back to the "main unit" mode by pressing the "Home" button.



Figure 23 – Home screen Cu mode

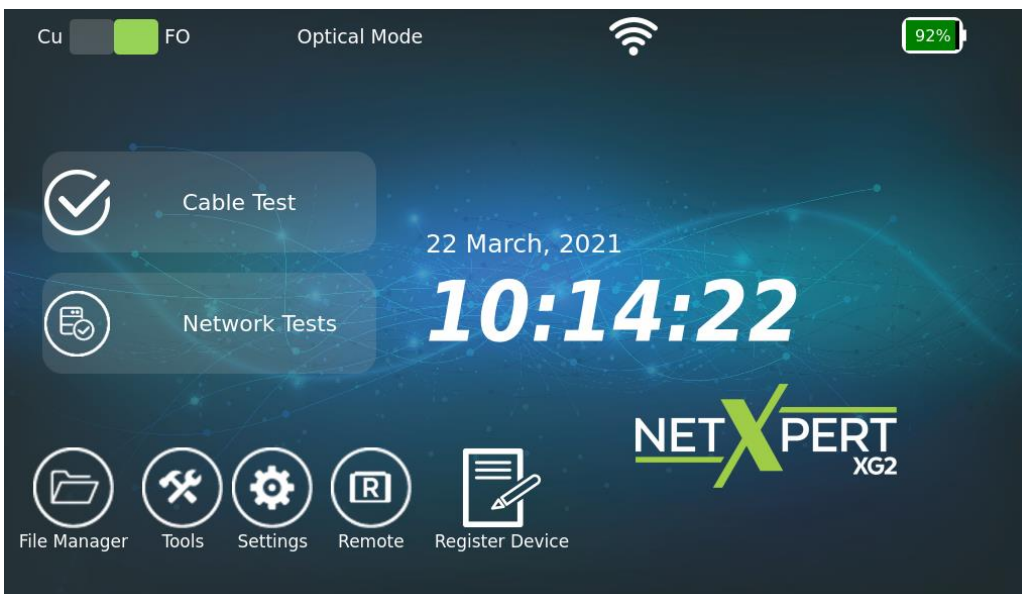

Figure 24 – Home screen FO mode

From the home screen, select **Cable Test** to get to the cable test menu. From there, other project-specific settings can be made. You can also start a new test run from here.

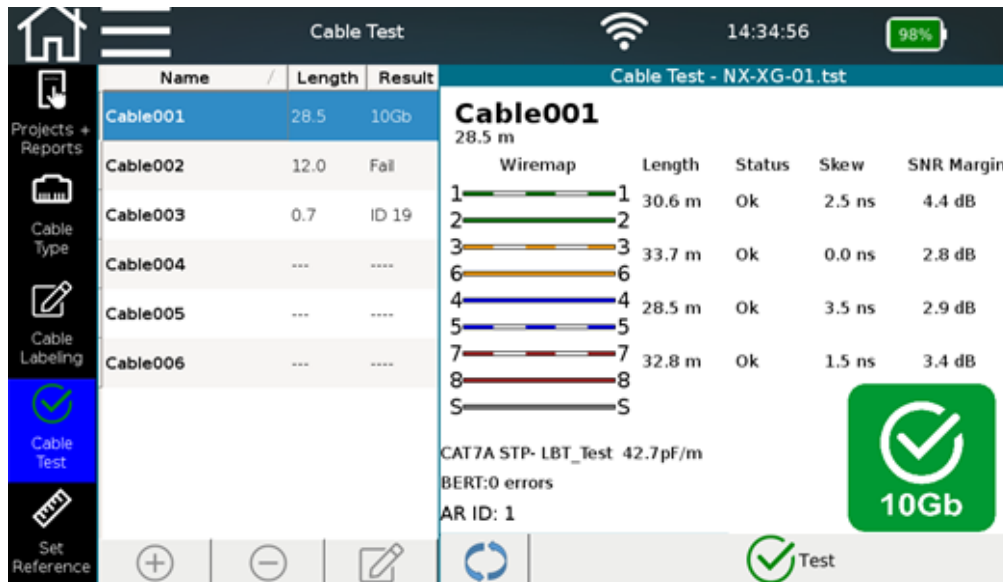

Figure 25 - Cable test screen after successful test run - Cu

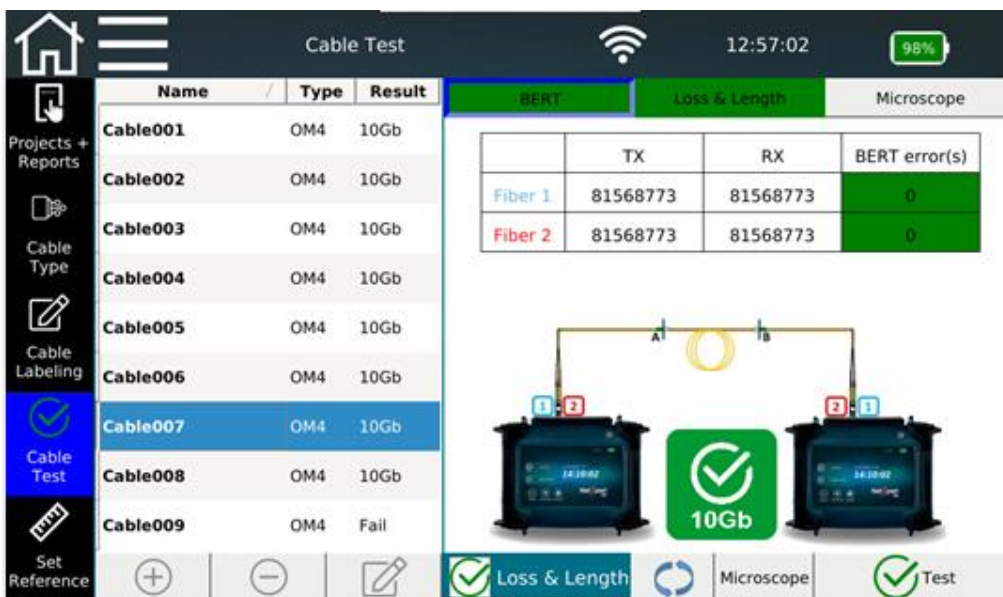

Figure 26 - Cable test screen after successful test run - FO

On the left side is the cable test menu. The cable list shows a typical test sequence one after the other and, if already populated, the list of cables tested/to be tested. On the right side is the test result of the selected cable on the left.

A qualification test can be started directly via the **Test** button.



Projects + Reports

Create a new project and enter specifications such as customer name or location. After completion or during the project, the report creation is also started here.



Cable Type

Configure the test parameters for the tests to be performed here.



Cable Labeling

Define how the individual measurements should be named so that they can more easily be found and assigned later.



Cable Test

This menu starts the test runs and displays the results.



Set reference

Include your test cables in the reference so as not to distort the length of the cable to be tested.



Add new cable.



Delete cable and test.



Edit cable name.

Label and attributes such as building, floor, room, etc. can be customized



Start Test.



Repeat test. No new test is created, the existing one is overwritten.



Microscope

Viewing and inserting microscope images of the fiber optic ends at OF measurements.



Loss & Length

Can be included in the test or not for FO measurements.



Projects + Reports

Once the feature is enabled, tap on the **Projects + Reports** icon to include customer information, create new test files, and cable test reports.

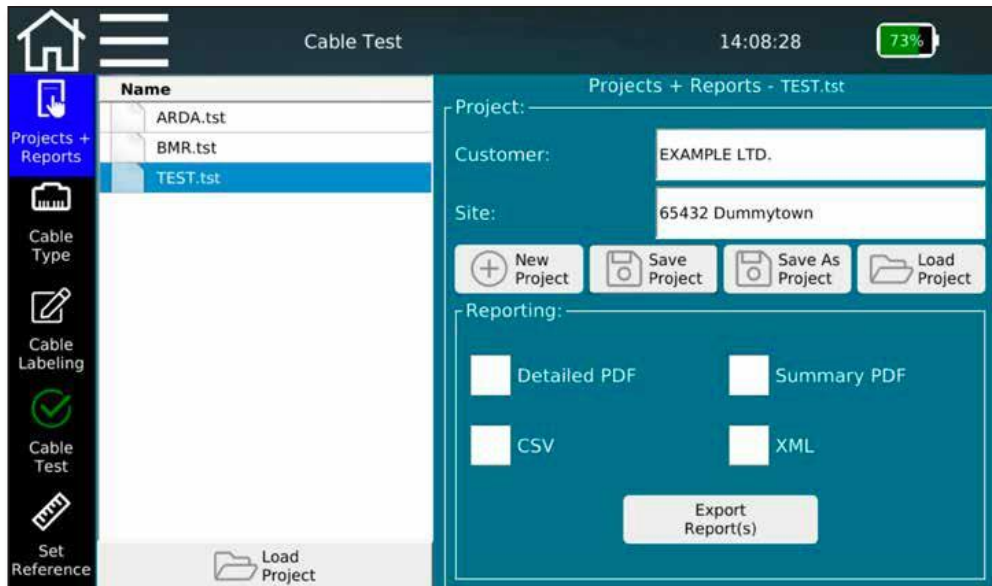

Figure 27 - Project settings with sample projects

In this screen, you can select from existing projects or create a new project and make project-specific settings. Here you can enter the customer name and location of the project and define the format in which the tests are to be output.

The above screen shows the currently open project from the list on the left. The details of the open project, customer and location data, are also displayed.

There are several buttons that allow you to create new projects, save changes to the detailed information and load projects via the file manager menu.

Selecting **New Project** opens a new window in which you can enter the name and location for the current project. With **Save Project**, you can save changed project details. The existing project name is retained. Using **Save as Project** makes it possible to save an existing project under a new name, for example after adjusting detailed information.

Load Project lets the user load an already saved project in the NetXpert XG2.

Internal documentation creation is controlled in the lower part of the screen. The device always stores its test results in its own TST format. These can be converted into an externally readable format during or after completion of the test series by selecting an available format type. You can choose from a variety of formats. On the one hand, there is a PDF summary in which one result row is displayed per test run. Or there is also a detailed PDF report which contains one or multiple summary pages, followed by detailed test results.

On the other hand, there is a CSV file as an open format for further processing of the results, e.g. in MS Excel. The creation of the respective format is started via

Export Report(s) and confirmed after completion.

Even if nothing has been selected in this window, the tests remain stored on the device in TST format and can be called up at any time.

Cable Type

Tap on the **Cable Type** icon on the left to configure the various test parameters. Here you can select, create and change the cable type to be tested and the desired test parameters.

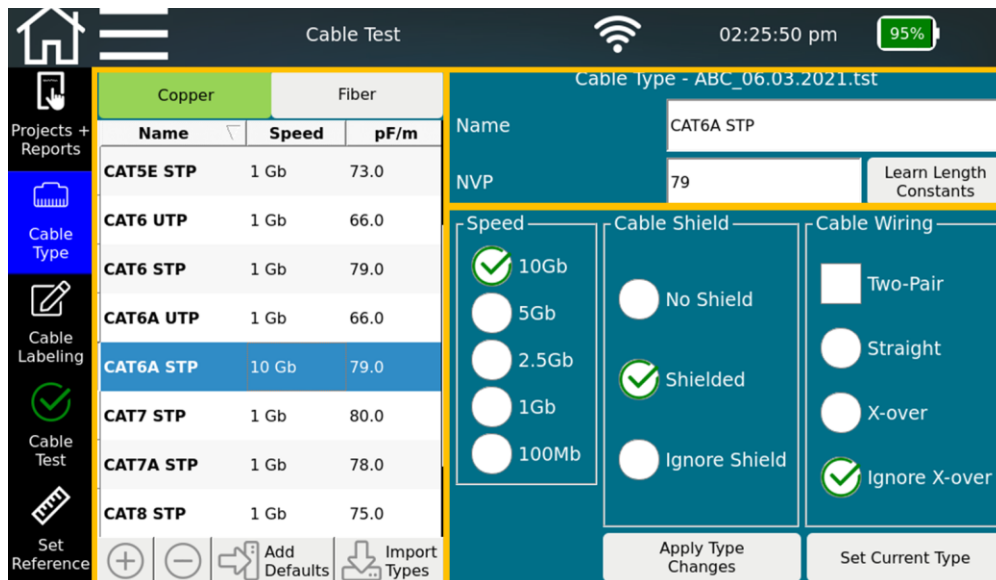

Figure 28 - Cable types and test parameters - Cu

The menu screen is divided into three main sections:

On the left is the default cable type list with templates for the creation of test standards. These serve as the basis for your own test configurations and extend to include self-created test specifications. External test standards can also be imported.

At the top right, you can find the details of the test standard currently used that is assigned to the project currently open. These include the name of the test standard and the cable constant for length determination, the propagation factor {NVP value} of the installed cable. In order to be able to determine the cable length correctly, the device requires the cable-specific values for NVP. Either you take this value from the data sheet of the cable or the NetXpert XG2 determines the values on a cable of known length {>30m}.

In the lower right section, you will find the details for the test standard. Under **Speed**, set the maximum Ethernet speed used for testing. Please note that, depending on the model of the device, fewer options may be available here. If the range is not sufficient for the requirements to be tested, your NetXpert XG2 can be upgraded at any time via a firmware license.

The cable structure is specified in the next two columns. **Cable Shield** takes into account whether the installed cable is with or without shielding. Error messages are issued as soon as the tested cable deviates from the setting as long as **Ignore Shield** is not selected here.

Under **Cable wiring**, you can select the orientation (crossover or straight through) and number of wire pairs. Error messages are issued as soon as the tested cable deviates from the setting as long as **Ignore X-over** is not selected here.

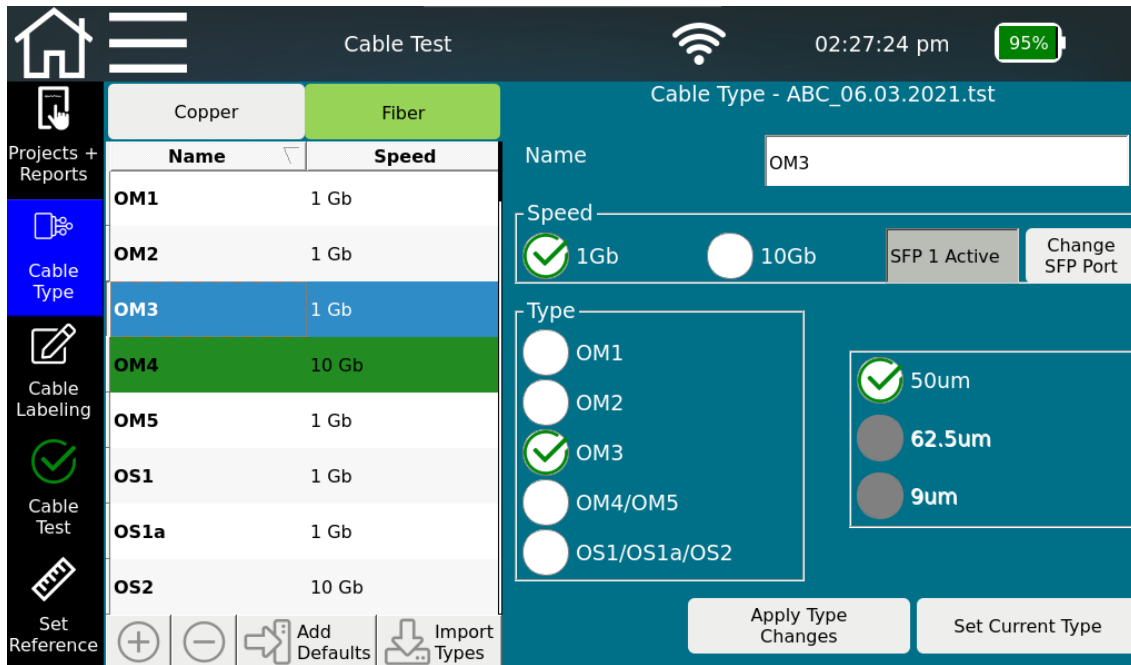

Figure 29 - Cable types and test parameters - FO

To change between copper and fiber interface, press the copper or fiber button above the cable type list. The cable type icon will change to FO and the menu screen will split into two main areas. On the **left side** the already implemented templates appear again. On the **right side** you will find information about **name, speed, type, core diameter and active SFP port**.

This typical sequence results from the options above for creating a new test standard:

- Select copper or fiber test interface - Cu or FO.
- Select a suitable template from the cable type list. The choices made should be as close as possible to the requirements to minimize the need for later adjustments. Direct use or modification of the templates should be avoided because it cannot be edited once the cable type is added to the cable test list.
- To copy and edit a cable type, select a cable type and press the plus icon at the bottom of the list. A copy will be added to the bottom of the list. Select the created copy, adjust the name and edit the parameters described above.
- Use **Apply Type Changes** to confirm the entries and **Set Current Type** for this project.



Cable Labeling

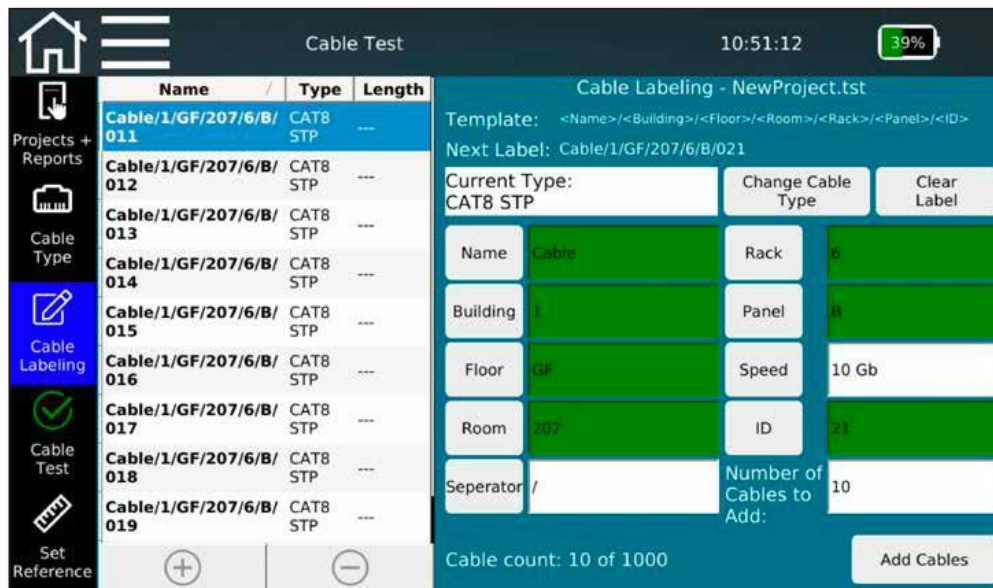

Figure 30 - Cable Labeling

- To define cable names for creating a test list, you can use the label buttons to insert individual variables into the name. Any number of name fields can be used from the selection list, and multiple separator characters can also be used. The order of the name components depends on the order of selection of the field name.
- In order for the cable test list to automatically increment, the cable **ID** number must be present in the name. It can be positioned anywhere in the template. If ID is not activated as a name component, an error message will appear.
- To add to the cable name, fill in the appropriate field and tap on the button to the left. The selected button will be shown in the template field at the top in the order it was selected. The current cable type is displayed in the **Current Type** field. Different test standards can also be used when creating cable names. **Change Cable Type** jumps back to the previous menu and allows you to select and activate another test medium or standard. However, this can no longer be changed for already created or measured test cables.
- The cable name template preview is displayed at the top along with the next label preview. The input can also be completely reset using **Clear Label**
- With the cable name defined, there are two ways to add cables to be tested to the test list. Individual cables can be added using the **+** symbol or several can be added using **Add Cables** - the number of cables is specified in the field above the add cables button. If the end of the list is reached during subsequent testing and you start another test run, the device adds a cable names according to the defined scheme. Individual cable names or tests can be deleted via the **-** button.

Cable Test

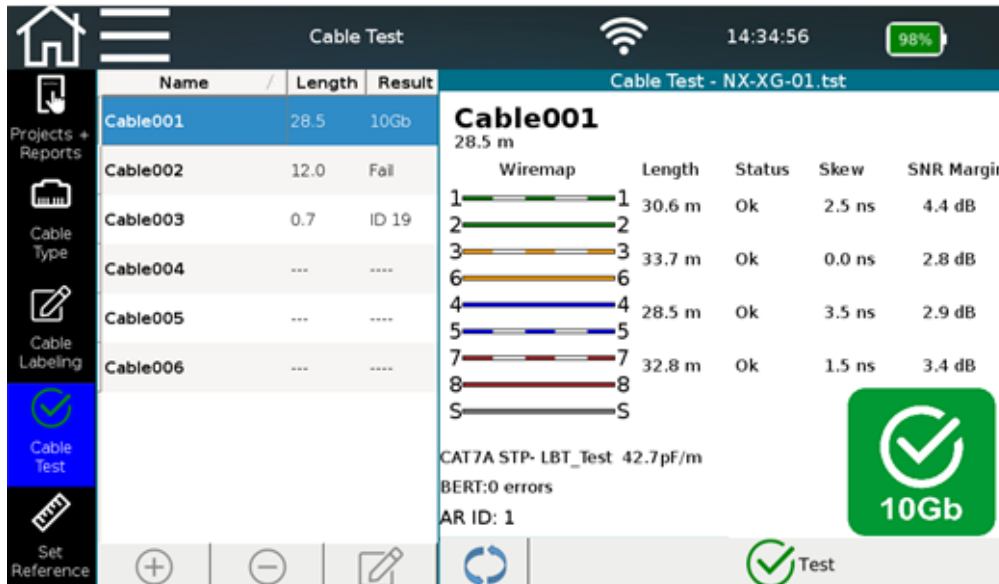





Figure 31 - Test screen with tested and untested cables - Cu

- The test screen appears when the **Cable Test** icon is selected. The cable test gives an overview of the cables tested or to be tested. You can start a new test from here and see the results of the already-completed tests.
- After pressing the **Test** button, a full test run with the selected cable name is performed. The next free cable is always selected from the list or when a new one is added below. Alternatively, a cable can be selected anywhere in the test to be tested.
- Press the **Retest** to repeat a test run without changing to the next cable name.
- After completing the test, you will see the results on the right. A green checkmark and the speed at which the test was run will be displayed if the cable passed the test .
- The addition and deletion of cable names is also possible here using the  and  buttons. Individual cable names can be changed using the  function.

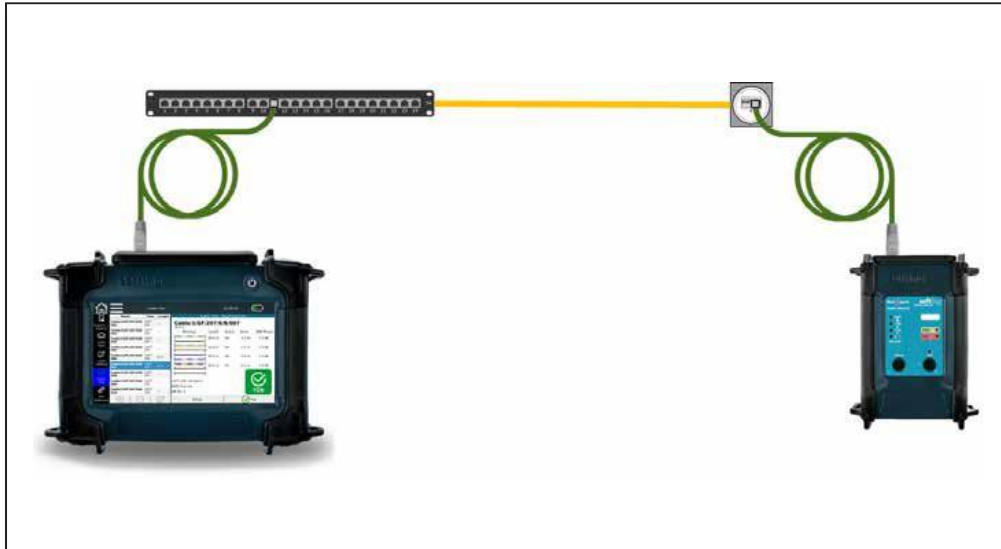

Figure 32 - Test setup for passive qualification test on copper links

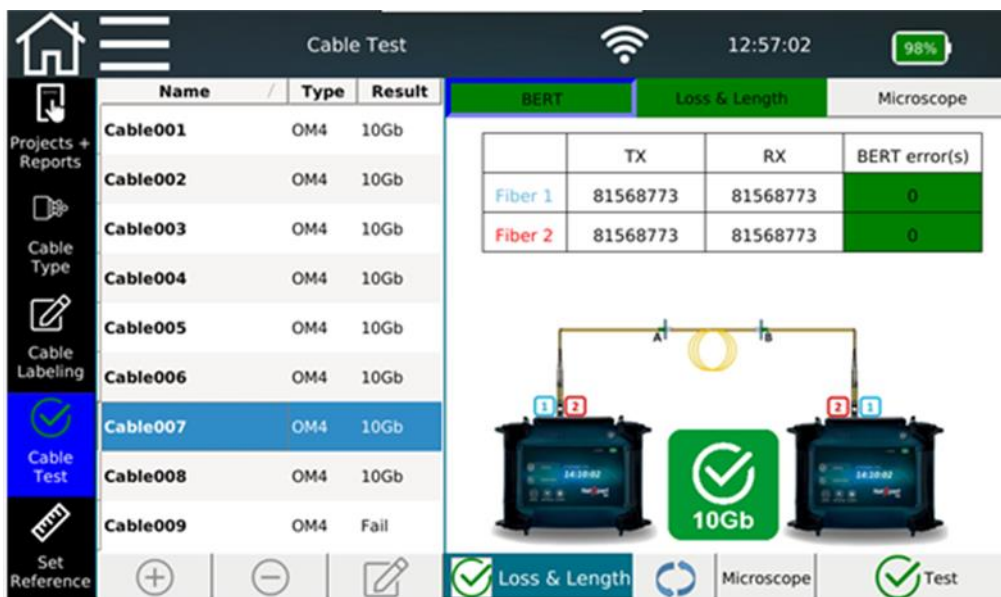

Figure 29 - Test screen with tested and untested cables - FO

- When testing fiber cables, you can decide whether these two parameters are included in the test by setting a check mark in the **Loss & Length** key. If they are included in the test, they are displayed in a separate tab in the top bar.
- Loss and length are purely informative parameters. If there is no BERT error, the test result is always a pass. However, the color turns yellow to alert the user to potential faults in the cable, in case of a too long cable or too high attenuation in the link.
- Enter the microscope menu by pressing the **Microscope** button. Do not forget to plug in the microscope prior to entering the mosaic screen.

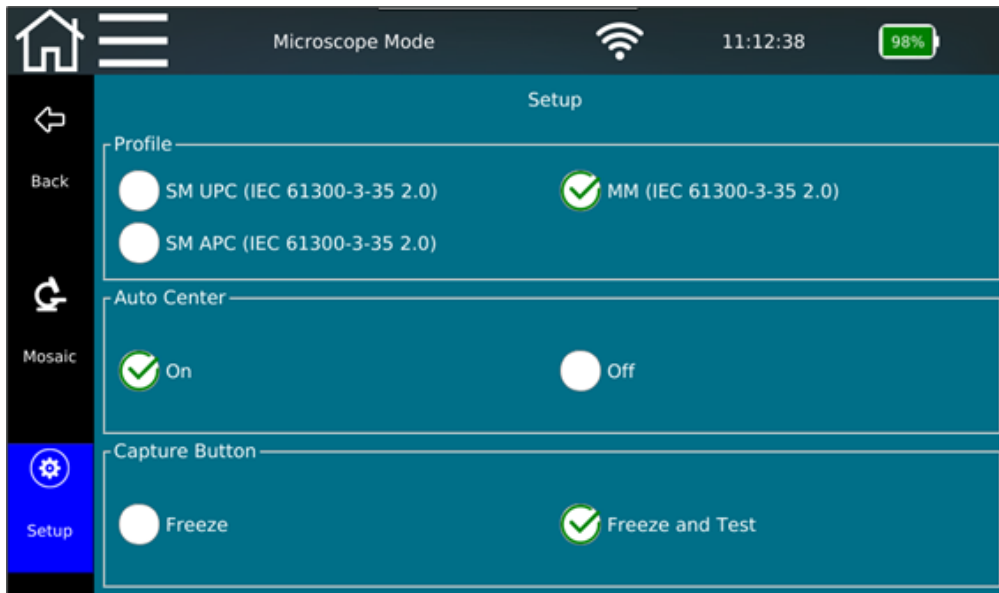

Figure 33 – Microscope menu

- Before performing a test using a microscope, check the correct settings and the corresponding hardware by going to the Setup menu on the left side.

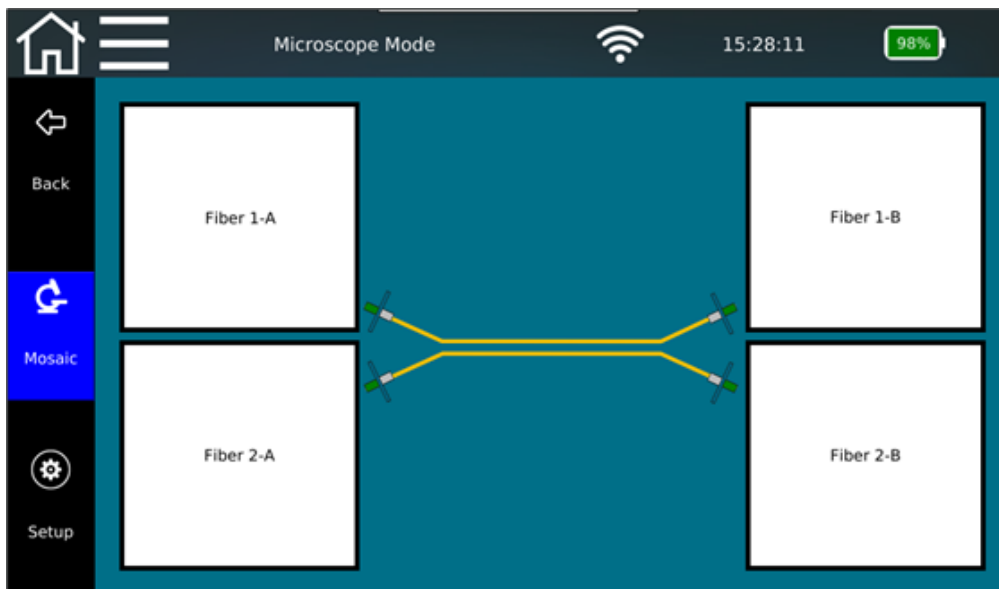

Figure 34 – Mosaik menu

- The **Mosaic** menu gives an overview of the connector end faces and their evaluation. Press one of the four fields to perform a microscope test of the corresponding fiber end.

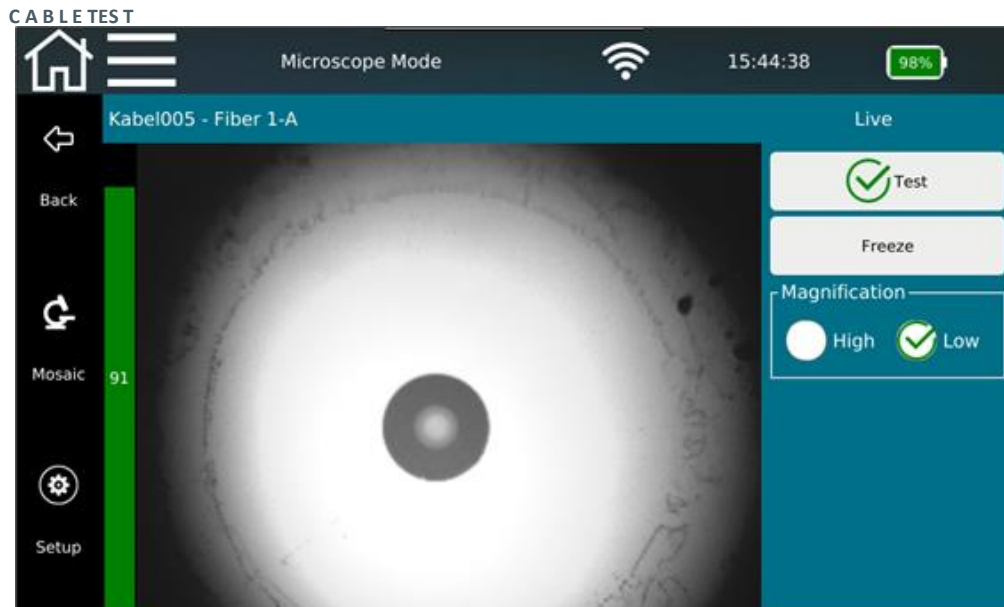

Figure 35 — Microscope test of a connector end face

- If the microscope is connected via USB and a live image of the microscope will appear on the screen. Insert the end of a fiber optic cable into the microscope until a clear image of the ferrule is displayed.
- On the right side of the screen you can influence the **Magnification** of the image and take a snapshot by pressing the **Freeze** button. Use the **Test** button to start a pass/fail evaluation of the connector end face.
- It is necessary that the focus bar display on the left side is above 50%, otherwise an error message will appear. By turning the focus wheel on the microscope, you change the focus.

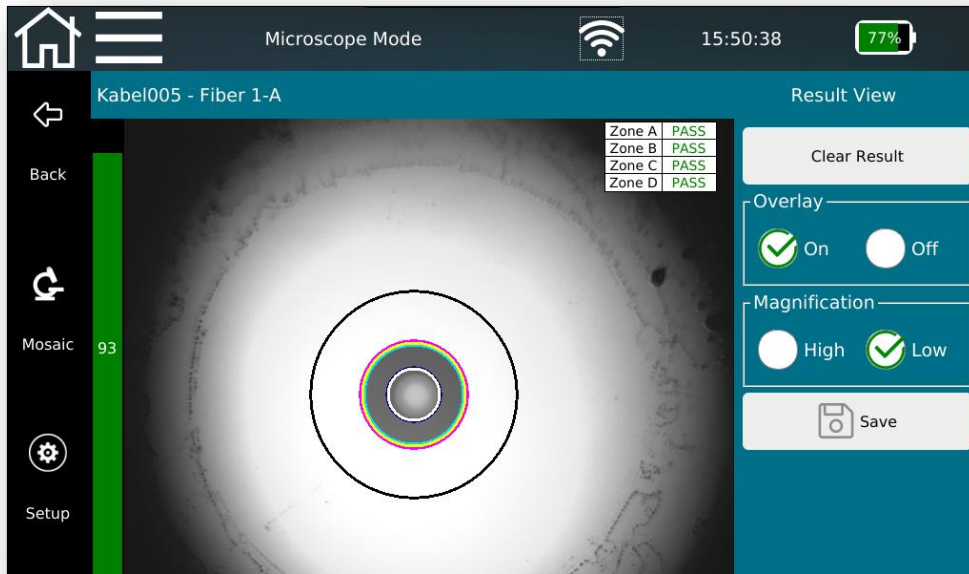

Figure 36 – Result View of Microscope test of a connector end face

- After you run the test, the Live View changes to the Result View.
- Here you have the option to hide the rating overlay and the rating table and to zoom in on the recording for better visual control.
- **Save** the result as a mosaic image or **Clear Result** to delete it and return to the Live screen.
- Press the **Back** button to return to the test screen and continue the test.

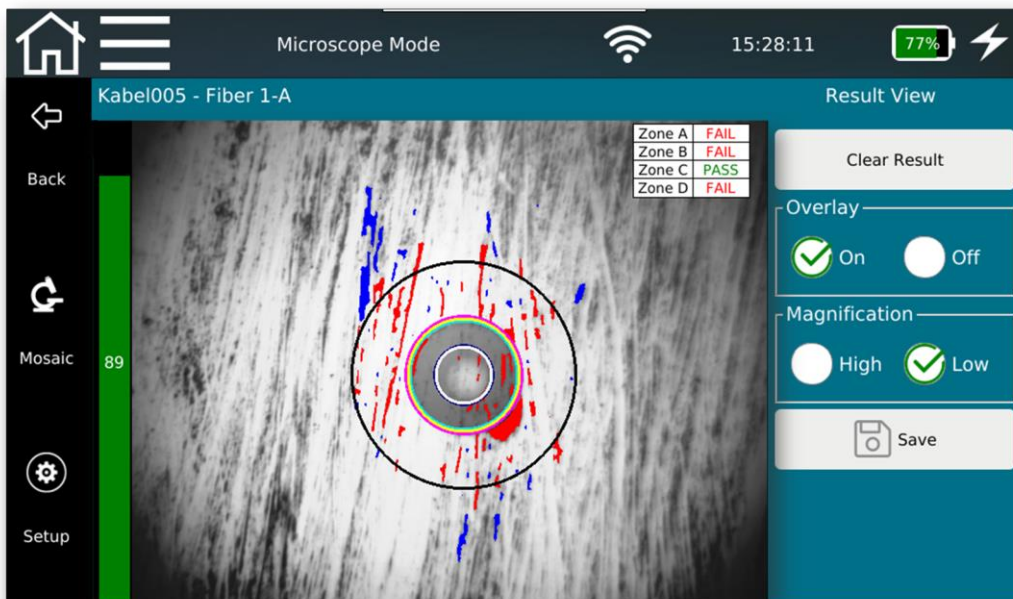

Figure 37 – Result view of a failed microscope test of a connector end face



Set Reference

To exclude the length measurement of patch cables, you can use **Set Reference** to determine the length of these cables and have the device automatically subtract them from the total length of the cable test.

Set Reference Copper

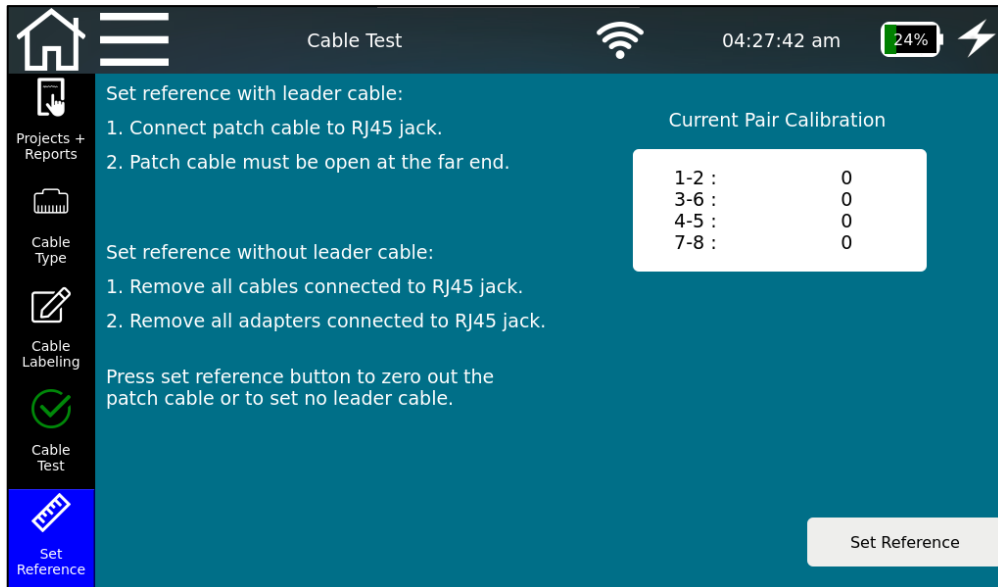

Figure 38 - Setting reference with or without test cords - Cu

Tests can be carried out on cables with or without the use of patch cables, depending on the type of cable termination being used.

Cable tests are typically performed with patch cables in order to test through a patch panel or keystone jack. Set reference is carried out as explained under "Set the reference with leader cables". If no patch cable is being used, "Set Reference" is used to calibrate the length measurement at the connector.

Follow the instructions on the screen to define and save the length of the patch cable. Be sure to connect the patch cable to the main unit only, do not connect the other end of the patch cable to the remote or networking equipment.

Select **Set Reference** to calibrate the patch cable length or NetXpert XG2 connector capacitance (pF), which will later be subtracted from cable test length measurements. The referencing procedure should be repeated when changing patch cables.



Figure 39 - Test setup for setting the reference - Cu

Set Reference Fiber

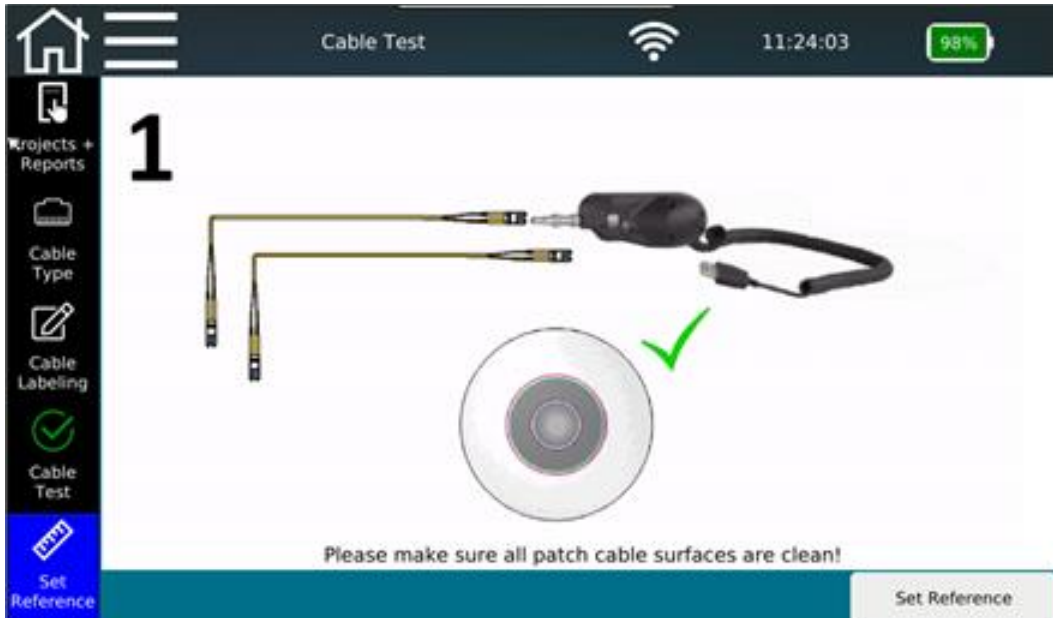

Figure 40 - Set Reference FO

If you only want to perform a BERT test of fiber cables, it is not necessary to set a reference. If you want to test Loss & Length, you have to set a reference first. Follow the instructions on the main unit, which are in the form of GIF's and explain the procedure.

Each time the test setup changes, it is necessary to set a new reference. When new SFPs are detected or a new cable type is selected, the user is prompted to set a reference.

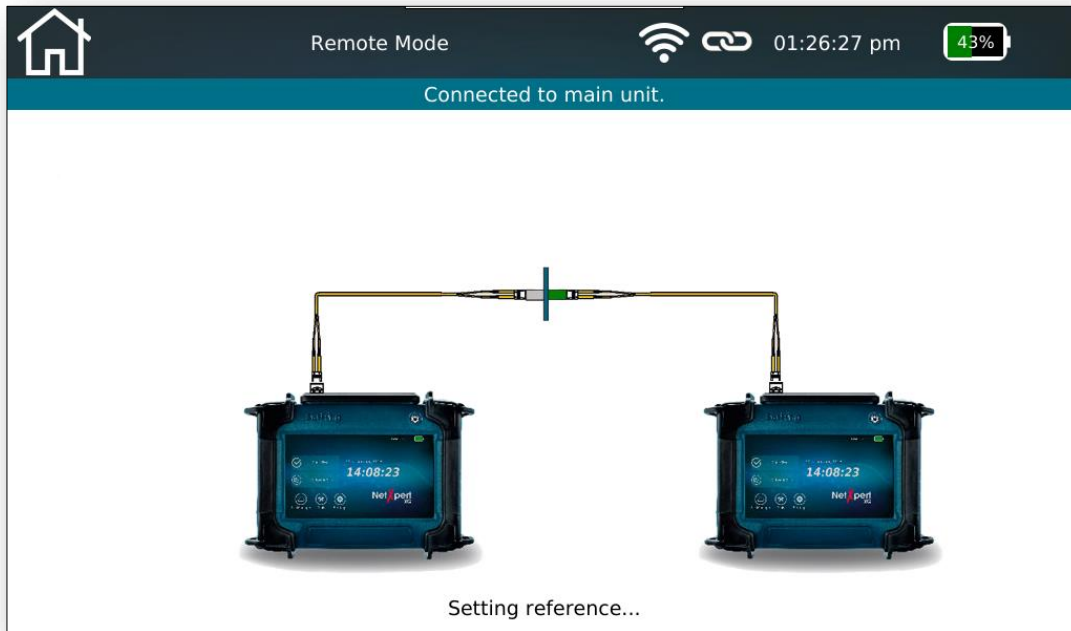

Figure 41 - Set Reference FO

Two patch cables and one fiber coupler are needed to perform a fiber set reference. Depending on the fiber type, OM4 or OS2 patch cables can be used that are delivered in the NetXpert XG Plus kit. In addition to the length values, set reference is done also for optical loss for fiber qualification.

Fiber optic set reference steps are as follows:

1. Clean fiber connector ends of patch cords and test them using a microscope.
2. Connect two patch cords using a coupler and insert them in main and remote unit.
3. Tap on “set reference” on the main unit and “remote” on the remote unit.



NETWORK TESTS

The NetXpert XG2 not only offers the ability to test passive cabling, but also checks active networks for function and locates the errors. It is suitable for use in commissioning an active network and simple diagnostics.

In **Network Tests** mode, the NetXpert XG2 supports copper, fiber, and WiFi in both IPv4 and IPv6 environments.

Depending on the device type, different Ethernet speeds are supported.

- NetXpert 1G
 - 100 Megabit and 1 Gigabit Ethernet
- NetXpert 2.5/5G
 - 100 Megabit and 1/2,5/5 Gigabit Ethernet
- NetXpert 10G
 - 100 Megabit and 1/2,5/5/10 Gigabit Ethernet

A license key allows a {subsequent} upgrade for all models up to 10 Gigabit Ethernet.

The device is connected either via the RJ45 copper connection, the SFP or SFP + connection for fiber optics or via WiFi by means of the internal antenna {in the 2.4/5GHz band}.



Figure 42 - Test setup for connecting to an active network

Link Status

Here is an overview of the connected network. The connection to the switch/router is established either via DHCP or static IP.

While the NetXpert XG2 is establishing a connection, the connection link icon flashes in the top menu bar. If a connection is made, the link icon stops flashing and the link status details are displayed.



Figure 43 - Link Status, wired connection {left} or via WiFi {right}



DHCP

Here you can request a DHCP server located in the network to send network data and obtain a network IP address. After tapping on the **Start Test** button, a **DHCP Request** is sent.

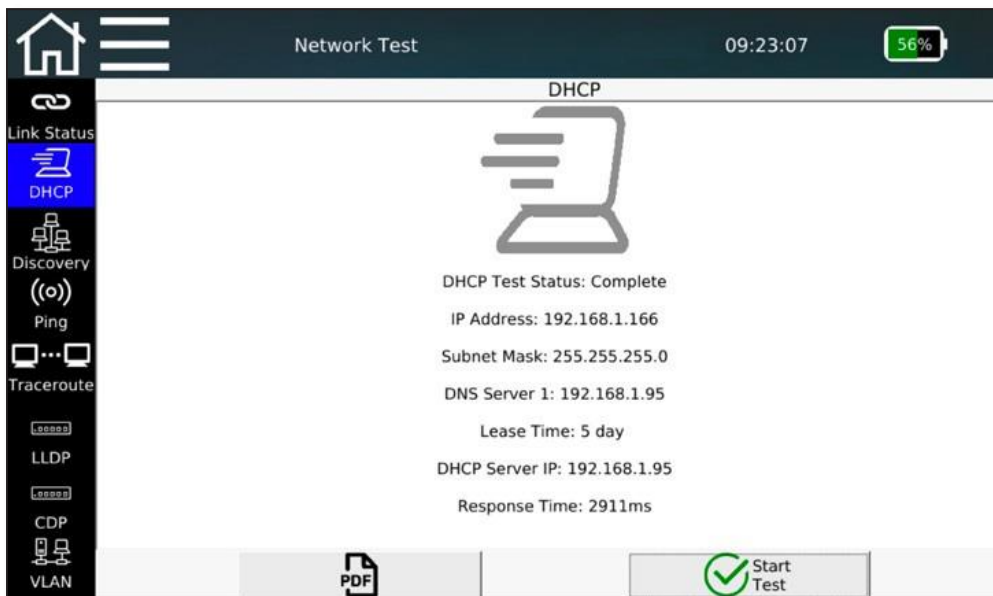

Figure 44 - DHCP test

The information received from the DHCP server is displayed and can also be saved in PDF format.



Discovery

Network discovery identifies connected network participants and displays their broadcast information. All participants found in the subnet {if possible} are grouped accordingly.

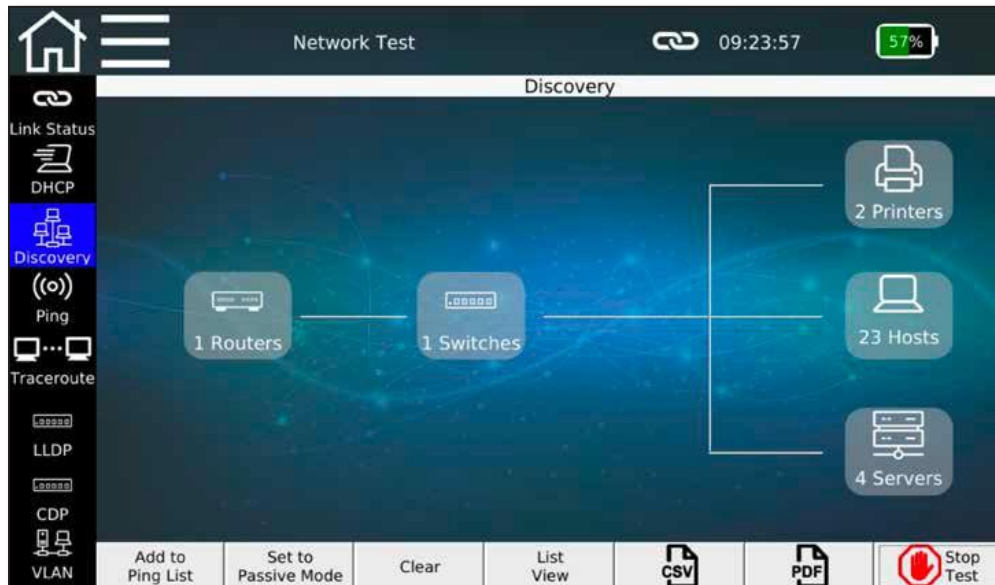

Figure 45 - Network detection {overview}

There are two different ways of discovering network devices using **Set to Passive / Active Mode**.

- **Active mode:** The NetXpert XG2 uses Active Resolution Protocol (ARP) to identify devices in the network and displays the received data for each device available. The NetXpert XG2 sends Ethernet telegrams to the network.
- **Passive mode:** The NetXpert XG2 only "listens" to the network and displays all broadcasting devices. However, less detailed information about the discovered devices may be available.

The NetXpert XG2 displays the MAC, IPv4, and IPv6 addresses of each discovered device as well as the DNS {Domain Name System} and NetBIOS {Network Basic Input Output System} name. Each device is assigned to a device type. There are 5 groups: Router, switch, printers, servers and hosts. The NetXpert XG2, however, can only display the information that is output by the respective devices. Therefore, reliable assignment to the device groups cannot always be made.

By tapping on a device group, e.g. **Hosts**, the display changes to the list display, in which each device found in this assignment is listed individually.

The **Lists/Overview View** button makes it possible to switch between the overview and list display.

If the device finds duplicate IP addresses in the network, these are highlighted in red.

Discovered addresses can be applied directly to the ping list of the following **Ping** function via **Add to Ping List**.

Clear can be used to delete the entire list of found network stations and a new search can be triggered via **Start Test**.

The list of found stations can also be saved directly in PDF and CSV format.

The screenshot shows the 'Network Test' application interface. The main display is a table titled 'Discovery' with the following columns: Mac Address, IPv4 Address, IPv6 Address, DNS Name, Netbios Name, and Device Type. The table contains 14 rows of data. The row with IP address 192.168.1.158 is highlighted in red. At the bottom of the screen, there is a control bar with buttons for 'Add to Ping List', 'Set to Passive Mode', 'Clear', 'Map View', 'CSV', 'PDF', and 'Stop Test'.

Mac Address	IPv4 Address	IPv6 Address	DNS Name	Netbios Name	Device Type
B8:CA:3A:8F:0C:...	192.168.1.119		technik-pc.dhcp.soft...	TECHNIK-PC	Host
F0:1F:AF:3A:7F:0A	192.168.1.167		huber-pc.dhcp.softi...	HUBER-PC	Host
78:45:C4:23:53:C5	192.168.1.115		pc-martinas.dhcp.so...	PC-MARTINAS	Host
10:FE:ED:C2:12:A8	192.168.1.25		No Such Name		Router
A4:1F:72:97:A3:C4	192.168.1.157		pc-schlote.dhcp.soft...	PC-SCHLOTE	Host
90:1B:0E:93:87:00	192.168.1.131		wwtd.dhcp.softing.c...	WWTD	Host
80:3F:5D:10:44:79	192.168.1.142		wfca-nb2.dhcp.softi...	WFCA-NB2	Host
F8:0D:60:75:02:A3	192.168.1.111		can-312x-04.psiber....		Printer
90:1B:0E:93:17:39	192.168.1.146		wwwy.dhcp.softing....	WWWY	Host
9C:5C:F9:E6:3D:...	192.168.1.143		No Such Name		Host
00:1E:4F:2B:09:1A	192.168.1.92		No Such Name		Host
00:26:73:58:A4:F2	192.168.1.82		ricoh2500.psiber.local		Router
00:22:BC:60:57:5F	192.168.1.158		No Such Name		Host
00:06:71:41:00:30	192.168.1.170		No Such Name		Host

Figure 46 - Network detection {list display with duplicate IP address}

((o)) Ping

The **Ping** function can be used to save multiple IPv4/IPv6 or domain addresses and ping them continuously.

Network Test					
Ping					
Target	Tx/Rx	Min (ms)	Avg (ms)	Max (ms)	
google.com	0/0	0	0.00	0	
yahoo.com	0/0	0	0.00	0	
facebook.com	0/0	0	0.00	0	
cnn.com	0/0	0	0.00	0	
192.168.1.1	0/0	0	0.00	0	
192.168.1.120	0/0	0	0.00	0	

Figure 47 - Ping list

The ping list shows the sent requests and responses for all addresses as well as the shortest, longest and average response time of the counterpart.

The addresses in the list are either entered manually via the **Add** button or created as a takeover from the previous network detection process. Both internal addresses and external domain names can be entered. Ping destinations can be edited via **Edit** and deleted from the list via **Remove**. The list of the ping results can also be saved directly in PDF and CSV format.

Traceroute

Traceroute makes it possible to trace the path to a network destination. All network gateways are queried on the way to the destination, provided that they are displayed as available with IP address and the resulting delay is shown.

Hop	Delay #1	Delay #2	Delay #3	Destination
1	1 ms	1 ms	1 ms	192.168.1.1
2	1 ms	1 ms	1 ms	213.30.210.161
3	9 ms	9 ms	9 ms	62.214.151.221
4	12 ms	13 ms	13 ms	62.214.34.249
5	17 ms	16 ms	37 ms	62.214.37.134
6	17 ms	16 ms	17 ms	89.246.109.250
7	13 ms	13 ms	12 ms	108.170.251.193
8	13 ms	14 ms	13 ms	209.85.251.239
9	16 ms	16 ms	16 ms	216.58.210.3

Figure 48 - Traceroute

Depending on the route traveled, a corresponding number of gateways is listed. Three data packets are sent and the corresponding response times are listed.

The destination to which the route should be determined can be entered or changed using the **Edit Target** button.

The list of the hops can also be saved directly in PDF and CSV format.

LLDP/CDP

The NetXpert XG2 is capable of detecting and evaluating LLDP {Link Layer Discovery Protocol} and CDP {Cisco Discovery Protocol} telegrams.



Figure 49 - LLDP and CDP information

Active components such as routers or managed switches may send LLDP or CDP broadcasts at regular intervals. This data is used for network management and gives status information about the components.

Each device is displayed on a separate page. The arrow keys can be used to scroll when multiple telegrams have been received from different devices.

The information obtained can be saved in PDF format.

VLAN

More and more networks are using VLAN {Virtual Local Area Network tags} to segment networks. The NetXpert XG2 can detect VLAN IDs {tagged according to IEEE 802.1q} and display the available VLAN information.

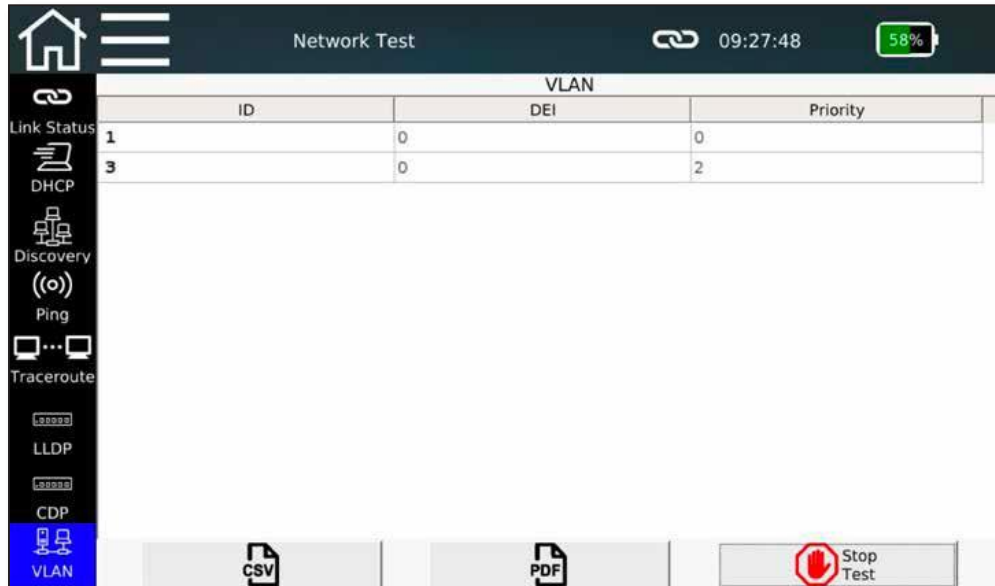

VLAN		
ID	DEI	Priority
1	0	0
3	0	2

Figure 50 - VLAN detection

The NetXpert XG2 is able to recognize broadcasted VLANs. Using a monitoring port on a managed switch is recommended. Depending on the configuration of the switch, it may happen that broadcast packets are not marked with VLAN IDs and thus no detection can take place.

The VLAN information is output in three columns:

- ID number of the VLAN
- DEI {Drop Eligible Indicator} - indicates that frames can be dropped if there is congestion {formerly CFI}.
- Priority - Priority information of the user





The list of VLANs can be saved directly in PDF and CSV format.







TOOLS

The tool menu is accessible from the start screen and reflects the interface (copper or fiber). Different tools are available in copper and fiber optic mode, which can be used for quick tests, targeted troubleshooting or cable localization, for example.

Copper:

-  Wiremap & Margin
-  Port Discovery
-  Individual BERT test
-  Tone Generator
-  Link Light

Fiber Optic:

-  Individual BERT test
-  Microscope
-  Live Light
-  Link Light

✔ Wiremap & Margin (Copper)

This function is used as a quick test to examine a copper cable for proper wiring, signal-to-noise ratio, and delay skew ensuring the ability to transmit a certain data rate.

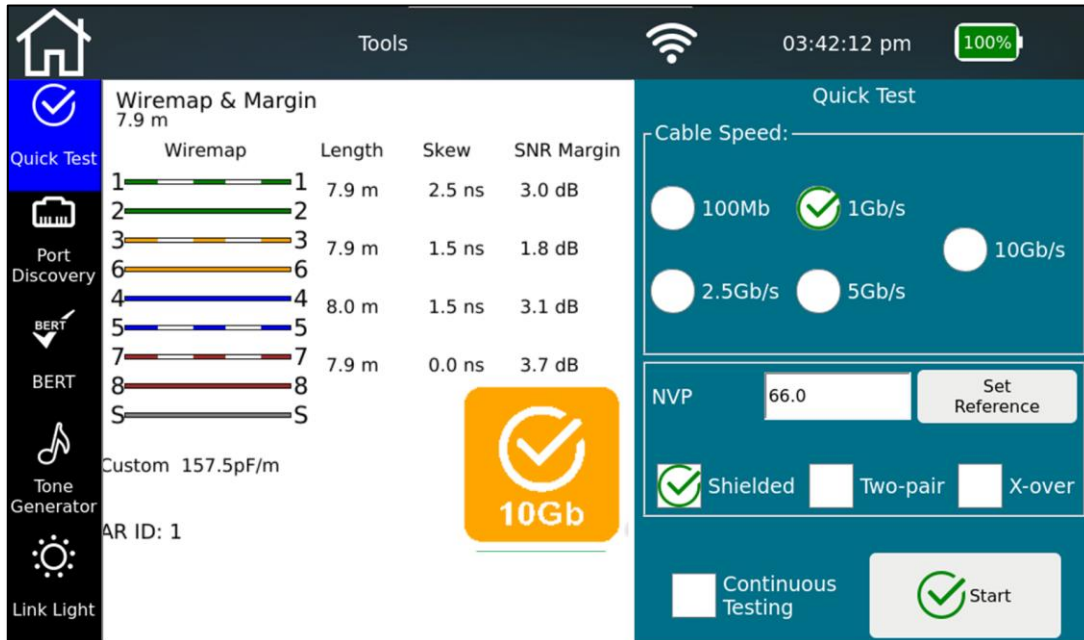

Figure 51 - Wiremap & Margin

Select the appropriate cable speed for the cable being tested. For the most accurate length determination, the NVP value of the cable to be tested is required.

Select Continuous Testing so the **Test** button does not have to be pressed before every run. The NetXpert XG2 will automatically perform cable tests at very short intervals. This facilitates troubleshooting and simple and quick testing of multiple cables.

The cable construction is freely selectable in advance, there is a differentiation between shielded and unshielded, straight or crossed, 4-pair or 2-pair versions. If there is a deviation from the set structure, an error message is output.

If there is no error in the cable the pass will be shown in “yellow” as this test does not consist of bit error rate test (BERT). A green pass is only shown when all four parameters of qualification (BERT, SNR, Skew, Wiremap) are tested, which can be run on “cable test” .

Port Discovery (Copper)

Port Discovery provides detailed information about supported Ethernet speeds and the PoE status on the switch port used.

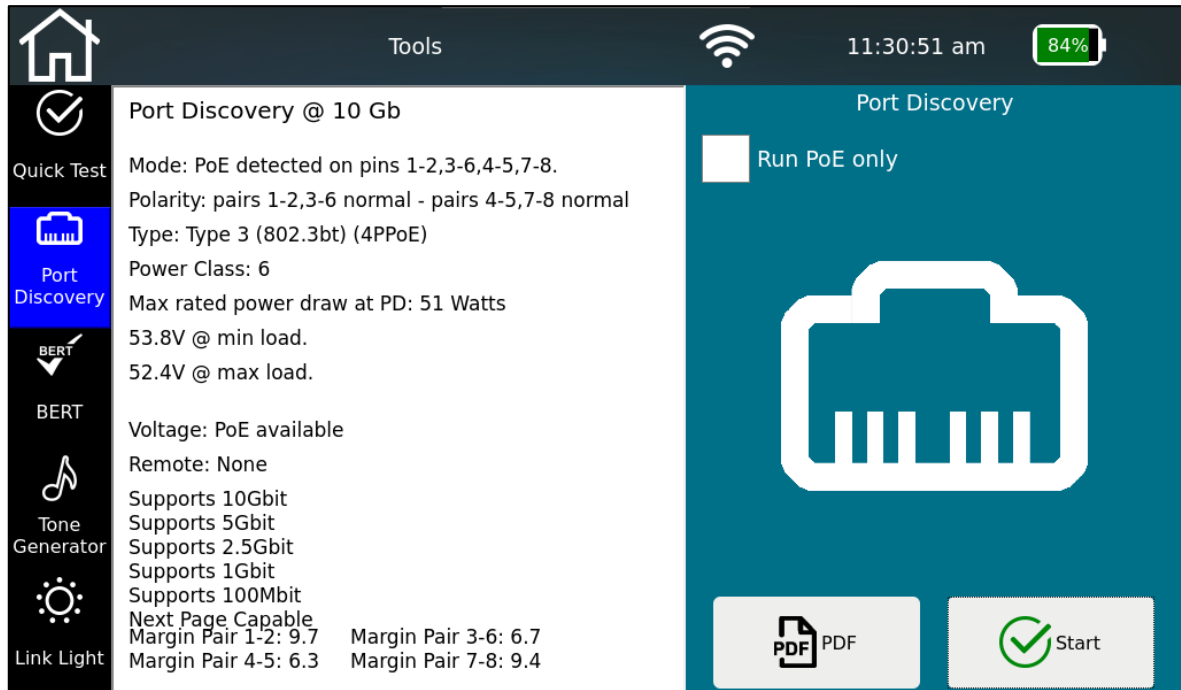

Figure 52 - Port detection

The NetXpert XG2 displays the Ethernet speed of the current connection and the other advertised speeds of the port.

The device performs a PoE evaluation on the port, which can also be performed as a single function {**Run PoE only** selection}. The operating mode, polarity, PoE standard and the performance class are displayed. A voltage load test is also performed to ensure reliable PoE under load conditions.

At the bottom of the screen SNR margin of each pair is also displayed.

Port Discovery results can be saved in PDF format.



BERT test (Copper)

The BERT test menu allows the user to run a Bit Error Rate Test at a specified speed and duration.

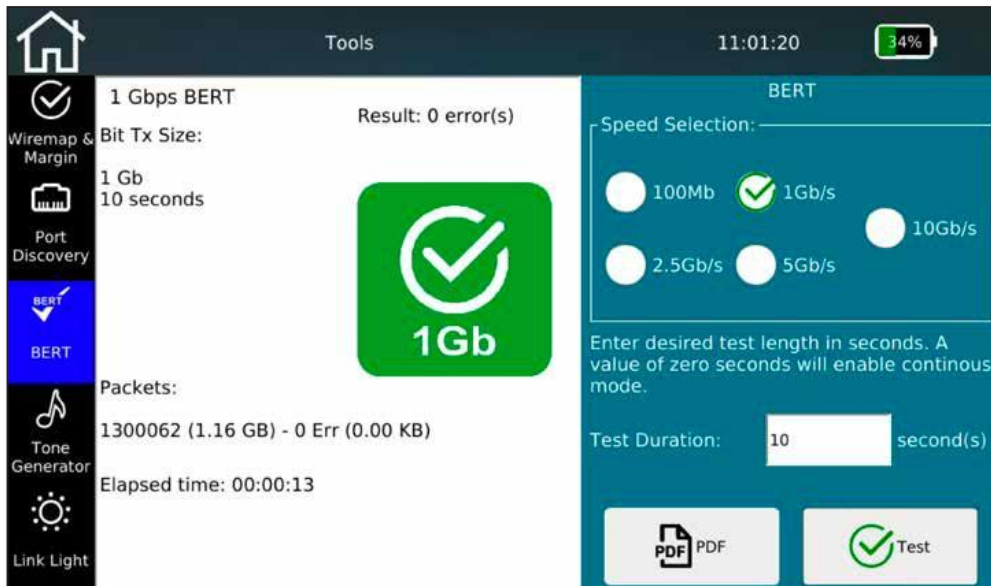

Figure 53 - Individual BERT test

Set the desired speed and the duration of the test. Select the test icon to begin the test. When the test is finished, the NetXpert XG2 will display a Green pass icon and the packet count. If errors were detected, the NetXpert will fail the test and display the quantity of dropped packets

The pre-set test times depend on the selected Ethernet speed and are based on statistical security {see table, 63% CL}.

Transmission format	Standards reference	Required Bit Error Rate in standards reference	Test time for 10% confidence level	Test time for 63% confidence level	Test time for 95% confidence level	Confidence level with 10 second test time
1G	IEEE Std 802.3ab	10^{-10}	1 second	10 seconds	30 seconds	63,0%
2.5G	IEEE Std 802.3bz	10^{-12}	42 seconds	6 minutes 38 seconds	19 minutes 58 seconds	2,5%
5G	IEEE Std 802.3bz	10^{-12}	21 seconds	3 minutes 19 seconds	9 minutes 59 seconds	4,9%
10G	IEEE Std 802.3an	10^{-12}	11 seconds	1 minute 39 seconds	5 minutes 0 seconds	9,5%

The test duration can be set between 0 and 300 seconds. The test takes place in reference to the comparison of the transmitted and received data packets.

The result of the BERT test can be documented in PDF format.

Tone Generator (Copper)

The tone generator helps locate cables by providing an audible tone using tone probe/inductive receiver {e.g., CableProbe 15 from Softing IT Networks}.



Figure 54 - Tone Generator

Select on which pairs of wires the tone should be output. The individual pairs can be signaled either selectively, or all pairs at the same time.

You can change the tone with the arrow buttons. There is a choice of high and low combination of tones to help locate a port or cable.

Tap on **Test** to start tone generation. The tone generator can be turned off by pressing the **Test** button again.

Link Light (Copper)

To identify which port the NetXpert XG2 is connected to on a switch, the NetXpert XG2 can flash the link LED on the switch port.

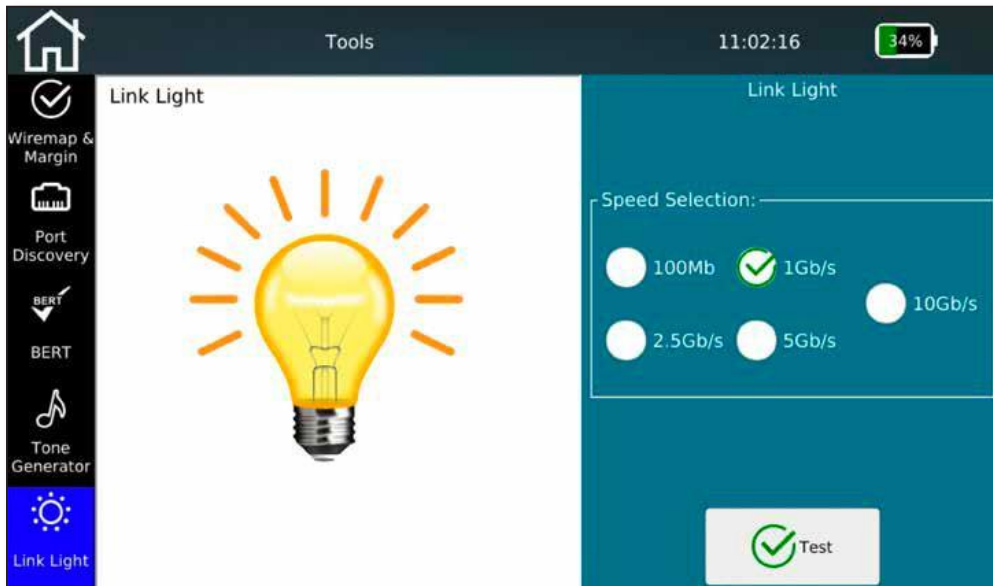

Figure 55 - Link Light Flashing

The connected switch port is detected by a slowly flashing Link LED {0.5Hz}. Select the desired flashing frequency and select **Test**.

Individual BERT test (Fiber Optic)

The BERT test carried out during the qualification test can also be started separately here.

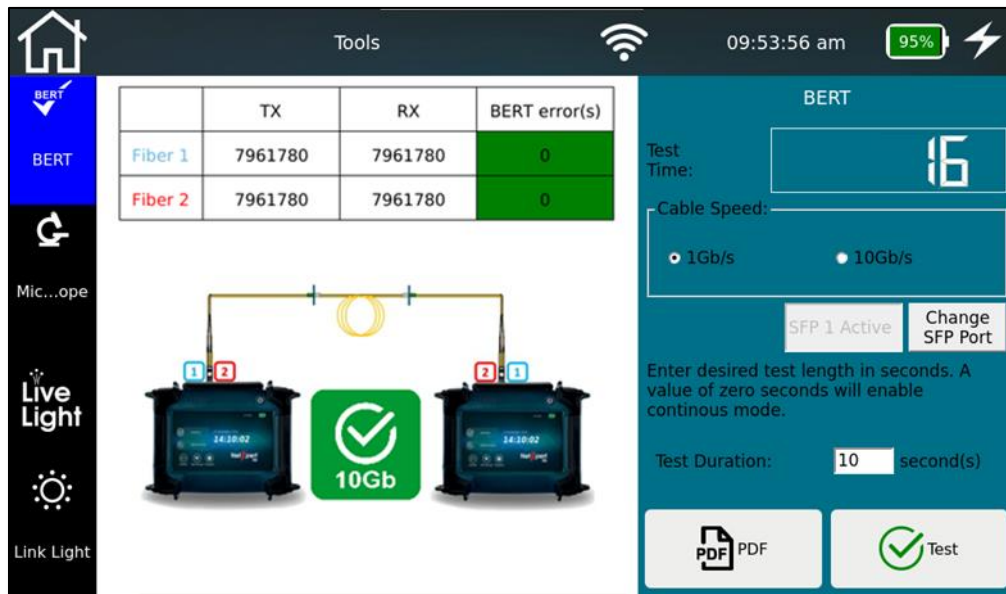

Figure 56 - Individual BERT test

Set the desired speed and the duration of the test. Select the test icon to begin the test. When the test is finished, the NetXpert XG2 will display a Green pass icon and the packet count. If errors were detected, the NetXpert will fail the test and display the quantity of dropped packets.

The pre-set test times depend on the selected Ethernet speed and are based on statistical security {see table, 63% CL}.

Transmission format	Standards reference	Required Bit Error Rate in standards reference	Test time for 10% confidence level	Test time for 63% confidence level	Test time for 95% confidence level	Confidence level with 10 second test time
1G	IEEE Std 802.3ab	10^{-10}	1 second	10 seconds	30 seconds	63,0%
2.5G	IEEE Std 802.3bz	10^{-12}	42 seconds	6 minutes 38 seconds	19 minutes 58 seconds	2,5%
5G	IEEE Std 802.3bz	10^{-12}	21 seconds	3 minutes 19 seconds	9 minutes 59 seconds	4,9%
10G	IEEE Std 802.3an	10^{-12}	11 seconds	1 minute 39 seconds	5 minutes 0 seconds	9,5%

The test duration can be set between 0 and 300 seconds. The test takes place in reference to the comparison of the transmitted and received data packets.

The result of the BERT test can be documented in PDF format.

Microscope (Fiber Optic)

Microscope tests can be performed in the Tools menu, independent of the cable test list.

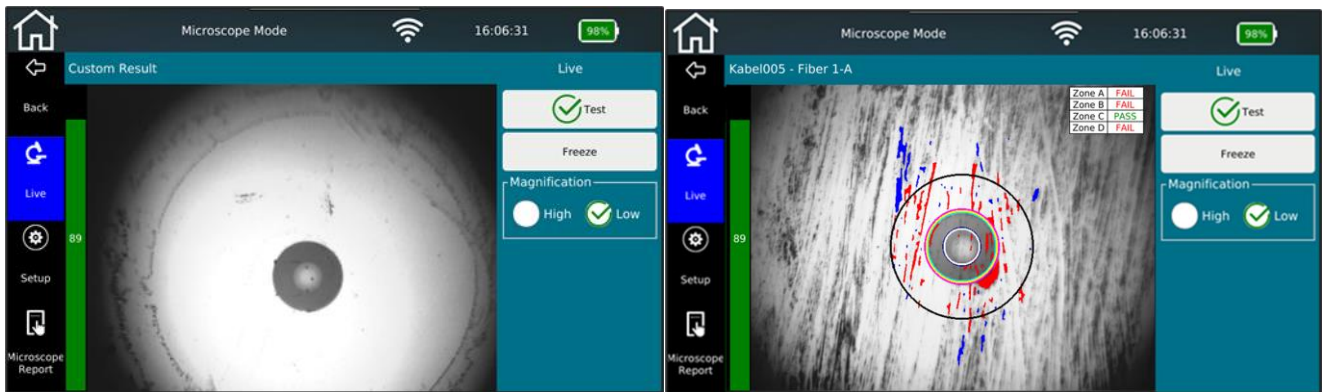

Figure 57 – Individual Mikroscope test

Results can be saved either with a pass/fail evaluation using the **Test** button or as an image without evaluation after pressing the **Freeze** button. Comments can be added to each image, which then appear in the **PDF** report.

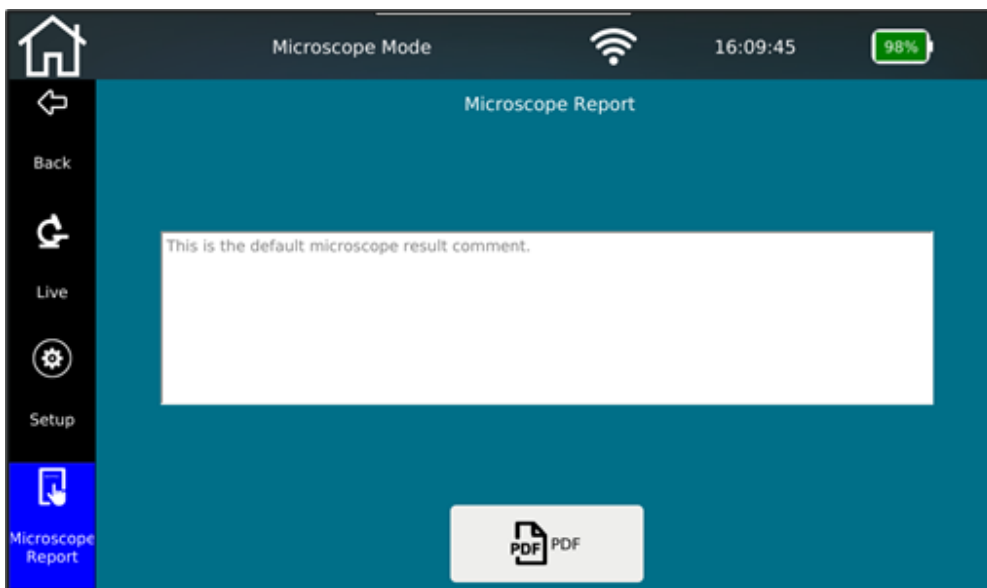

Figure 58 – Mikroscope report

LiveLight (Fiber Optic)

The LiveLight tool can be used to evaluate cable attenuation over time.

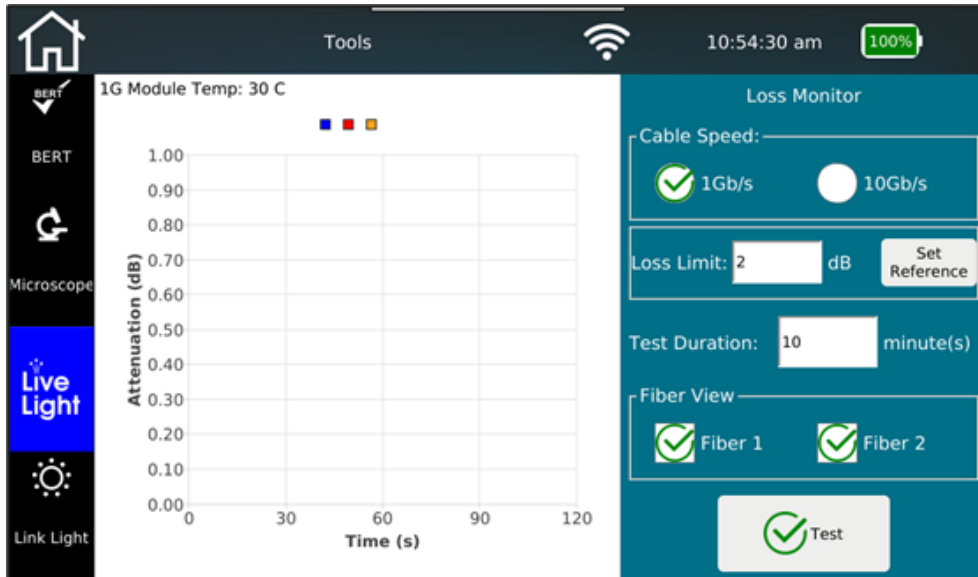

Figure 59 - LiveLight Start Screen

LiveLight shows a diagram of Attenuation (db) over Time (s). As with the cable test you should set a reference before starting the test. The limit value and the test duration can be set before the test starts. Individual fiber connections (Fiber 1/Fiber 2) can be tested by selecting the cable to be tested under the Fiber View option.

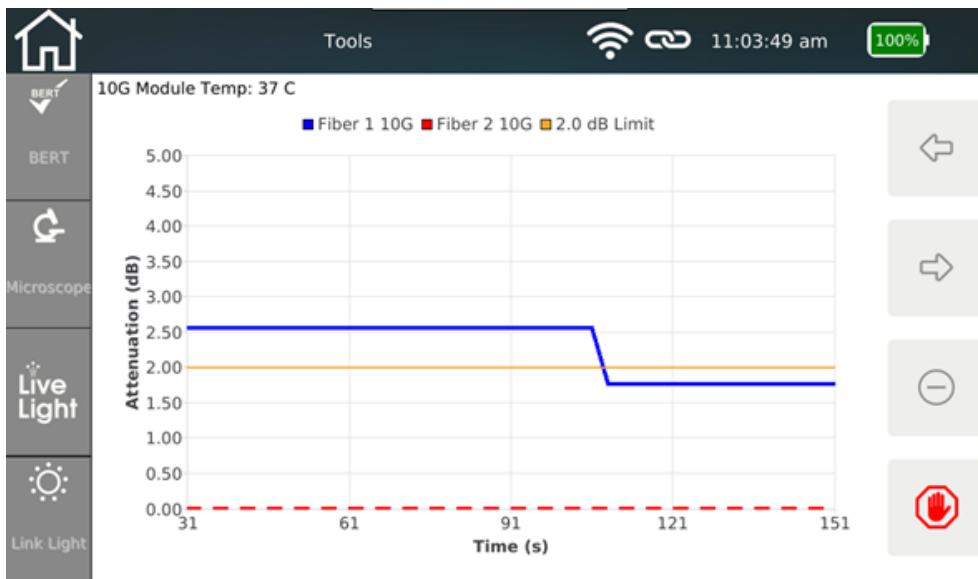

Figure 60 – LiveLight Measurement started

Changes in attenuation can be observed in real time in the attenuation/time chart.

The arrows can be used to move between time windows and see the difference in attenuation value over time. deletes the result while in live mode. The test automatically starts from zero. Press to end the live test.



Figure 61 – LiveLight measurement finished

The test data can be saved as a CSV reports. To do so, press the CSV button on the right side, which will save the report in the File Manager. Press the back button to return to the LiveLight test screen.

Link Light (Fiber Optic)

To identify which port the NetXpert XG2 is connected to on a switch, the NetXpert XG2 can flash the Link LED on the switch port.

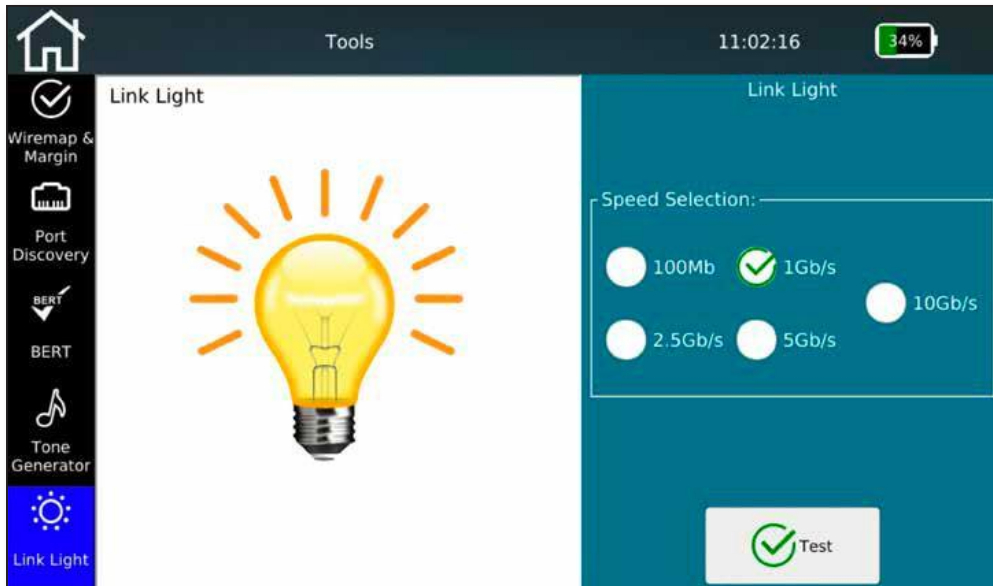

Figure 62 - Link Light Flashing

The connected switch port is detected by a slowly flashing Link LED {0.5Hz}. Select the desired flashing frequency and select **Test**.



FILE MANAGEMENT

The File Manager can be accessed directly from the home screen. In this menu, you can create projects and load firmware update files. In addition, logos can be imported for report generation and license keys can be transferred to extend the range of functions.

The main function is to exchange test data between the internal memory and external medium by means of a USB stick.



Figure 63 - File Manager {left only internal memory, right internal and external memory with connected USB drive}

You can use the File Manager to manage both the internal and the external files {e.g. of an attached USB memory}.

The left side displays the internal memory and the content of external memory is displayed on the right when a USB stick plugged in.

You can use the buttons at the bottom of the screen to create a **New Dir**, **Delete** and **Rename** files and directories.

You can also copy files and directories from left to right and vice versa.



You can use the filter icons to hide individual file types to improve the overview.



You will find different file types on the NetXpert XG2. The original test data has the "*.tst" extension and cannot be changed or read externally. Test reports are saved in PDF format (detailed PDF and summary PDF).

In addition, an open CSV format is still available to read in and process test results, e.g. in MS Excel.

MAINTENANCE

With the exception of the RJ45 socket, neither the main device nor the Active Remote have any user parts that can be serviced by the user.

RJ45 SOCKET

Since RJ45 sockets are subject to wear and potential damage from an improperly crimped connector, it is possible to remove the socket and replace it with a new one.

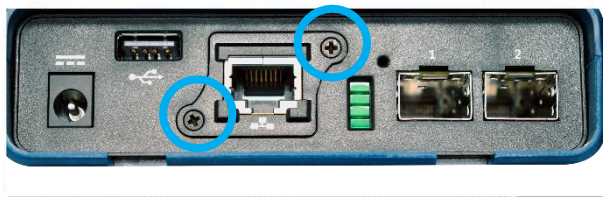

To do this, remove the two small screws on the RJ45 socket.

Insert an RJ45 cable into the socket. It is important that the locking lug of the plug engages in the socket. Now pull the socket with the cable out of the device.

To install a new socket, proceed in reverse order.

BATTERY

The NetXpert XG2 uses a lithium-ion battery. To charge the battery, connect the charger to the charging socket on the side of the tester and connect the charger to the power source. Make sure the battery was charged overnight or for at least 5 hours, before using NetXpert XG2 for the first time.

This increases the accuracy of the charge status display in the long term.

The battery of the NetXpert XG2 cannot be serviced by the operator. In the event you need to remove the battery, loosen the screws on the back of the NetXpert XG2 and disconnect the cables from the battery. Be sure to disconnect any cables that connect the battery to the device.

Users that require longer battery life for their NetXpert XG2 may purchase optionally a “high energy batter pack”, which consists of two lithium-ion cells in addition to the classic NetXpert XG2 battery.

Note:

The high-quality Li-ion battery is designed for the entire life of the tester. Li-ion batteries are hazardous waste and must be disposed of in accordance with local regulations.

CLEANING

Use a clean, damp cloth to clean the NetXpert XG2. Before cleaning, disconnect all cables from the device. Otherwise it may damage the device and cause personal injury. Do not use harsh or abrasive cleaners or solvents.

STORAGE

When not in use, store the NetXpert XG2 in the supplied protective case.

The NetXpert XG2 must not be exposed to high temperatures (over 80°C) or moisture. See the temperature limits in the *Specifications* section.

SPECIFICATIONS

Specifications	Description
Power supply	<ul style="list-style-type: none"> • Power supply: Input 100-240VAC, 50/60Hz Output 12VDC 2.5A • DC voltage input socket: 10-28VDC, 20W max. • Battery: Li-ion battery, 7.8V, 5500mAh, initial capacity
Connections	<ul style="list-style-type: none"> • Shielded RJ45 socket, 8 contacts • 2 SFP+ ports
Interfaces	USB
Altitude	Up to approx. 3,000m
Temperatures	<ul style="list-style-type: none"> • During operation: -10 to 60°C • Storage: -30 to 70°C • When charging: 10°C to 40°C
Permissible humidity	10 to 90% non-condensing
Housing	Impact-resistant plastic with rubber coating
Dimensions	<ul style="list-style-type: none"> • 245 x 177 x 73mm (main device) • 130x177x55mm (Active Remote)
Weight	<ul style="list-style-type: none"> • 1.2kg (main device) • 0.6kg (Active Remote)
Safety compliance	
Warranty	1 year

FREQUENTLY ASKED QUESTIONS

Q Why does the NetXpert XG2 show the cable length in red and report that the cable test has failed?

A The NetXpert XG2 tests for compliance with IEEE 802.3 connection specifications. If the cable is longer than 328ft/100m, the NetXpert XG2 does not perform an Ethernet Speed Certification and declares the test to be faulty.

Q What is a TST file?

A TST files are the original file format of the NetXpert XG2. They contain the respective cable tests performed in this project.

Q How do I get a firmware update for my NetXpert XG2?

A Go to the Download Center at itnetworks.softing.com/downloads to access updates for the NetXpert XG2 or go directly to itnetworks.softing.com/xgfirmware

Q Why do I not get a DHCP result in the link status test or network test?

A There may be different reasons why the NetXpert XG2 is not assigned an address. Make sure that DHCP and DHCP DNS are selected in the settings menu, perform a VLAN test and make sure the device is not connected to a tagged VLAN port. If there is still no address assigned, check whether the test cable is actually connected to an active port.

Q How many cable tests can the NetXpert XG2 store?

A The NetXpert XG2 can store several thousand cable tests in its internal memory.

Q Does the NetXpert recognize XG PoE (Power over Ethernet)?

A Yes, the NetXpert XG2 detects PoE, PoE+ and PoE++, PoE mode and min/max voltages under load.

Q Why is the length wrong and all my outlets show split-pair errors?

A This problem is common when laying cables on the distribution panel. Some distribution panels loop the signals through boards that have LEDs, for example, to display traffic or built-in noise canceling. These features change the cable properties and thus influence the test results.

Q Why is the length wrong and all my outlets show split-pair errors?

A This problem is very common when placing cables on distribution panels. Some distribution panels loop the signals through circuit boards that have, for example, LEDs to indicate traffic or integrated noise reduction. These features change the cable characteristics and thus influence the test results.

Q What do the terms miswire, open circuit and short circuit mean?

A Miswire is any incorrect pin assignment between both ends. An open circuit is caused by an unfinished conductor between the near and far ends. This can also happen when cables are cut. A short circuit occurs when two conductors are shorted together.

Q What is the SNR margin?

A The signal to noise ratio is determined by measuring the signal generated by the far end (active remote/switch). The far end device transmits Ethernet signals, which the NetXpert XG2 uses to measure the quality of the Ethernet signals. If the signal jitter is outside the Ethernet spectrum, it affects the quality of the signal, which is identified as SNR dB measurement. The SNR margin is the margin between the measured value and the application's acceptable limit.



CUSTOMER SERVICE

For technical information, see

itnetworks.softing.com

If you would like to contact our customer service, send an e-mail to

support.itnetworks@softing.com

WARRANTY STATEMENT

For a period of 12 months from the date of sale, Softing IT Networks GmbH guarantees that the product, when used properly and in compliance with the operating instructions, is free of material and processing errors.

THIS IS THE ONLY WARRANTY PROVIDED BY Softing IT Networks AND APPLIES EXPRESSLY IN LIEU OF ALL OTHER EXPRESS OR IMPLIED GUARANTIES, INCLUDING, BUT NOT LIMITED TO, ALL IMPLIED GUARANTIES REGARDING MARKETABILITY OR SUITABILITY FOR A PARTICULAR PURPOSE.

If parts of the product or the quality of execution prove to be deficient, Softing IT Networks GmbH will, at its sole discretion, repair or replace the product for the buyer free of charge. Softing IT Networks GmbH bears only the shipping costs from the location of the buyer to Softing IT Networks GmbH. This is the SOLE AND EXCLUSIVE COMPENSATION CLAIM under this Agreement. Devices damaged by negligence, accident or improper use or devices modified or repaired by an unauthorized workshop are excluded from the guarantee.

To return a product to Softing IT Networks GmbH, the buyer needs a Return Authorization Number (RMA) from customer service, which is available at +49 89 4565660. The RMA number must be clearly visible on the shipping document. Claims for defects according to our General Terms and Conditions shall remain unaffected.

RETURN ADDRESS:

Softing IT Networks GmbH
Richard-Reitzner-Allee 6
85540 Haar
Phone: +49 89 45 656 660

RMA-Nr. XXXXXX

EMEA

Germany

Softing IT Networks GmbH

Haar

+49 89 45 656 660

info.itnetworks@softing.com

France

Softing SARL

Creteil, Ile-de-France

+33 1 45172805

info.france@softing.com

Italy

Softing Italia Srl.

Cesano Boscone, Milan

+39 02 4505171

info@softingitalia.it

NORTH AMERICA AND CANADA

Softing Inc.

Knoxville, Tennessee

+1 865 251 5252

sales@softing.us

ASIA PACIFIC

Singapore

Softing Singapore Pte. Ltd.

Singapore

+65 6569 6019

asia-sales.itnetworks@softing.com

China

Softing Shanghai

Shanghai

+86 21 61063031

china-sales.itnetworks@softing.com

For technical information and support, please contact the Softing office in your country.

itnetworks.softing.com/contact

