

Excel 2 Way GOP Box Plus 25mm (10-Pack)

Item Code: 350-639

excel
without compromise.



✕ 2-Way

✕ 25 mm knockout for conduit

✕ 25 mm 'L' Brackets available

✕ 6c aperture size

✕ Accepts Category 5e, Category 6 or Category 6A

✕ 25 Year system warranty

Product Overview

The Excel Grid Outlet Position (GOP) Box Plus has been developed from the successful original versions. This range is available in four versions from 2 Way to 12 Way. The 2 and 4 way are available with a 25mm flexible conduit fixing point. The 4 and 6 way are available with a 32mm flexible conduit fixing point. The range has been developed for fixing to the end of flexible conduit typically where outlets are presented in a grid layout with cable containment mounted within a raised floor system. The GOP Box then has a degree of flexibility to be positioned within the radius of the flexible conduit to suit the office layout. 25 mm and 32 mm "L" Brackets are available to fix the other end of the flexible conduit to the floor slab. GOP Boxes are typically then attached to the underside of the desk, the flexible conduit passing through the floor tile via a grommet.

These Plus versions are enhanced with cable tie saddles adjacent to the conduit fixing point to accept either nylon or hook & loop ties. This permits the cable to be secured if required. Additionally the GOP box has a hole at each end of the upper case to accept self-tap screws for fixing to adaptor plates or bespoke brackets. Supplied with the GOP Boxes are black rubber blanks for the un-used 6c apertures. The 2 way is supplied with 1 blank, the 4 way is supplied with 2 blanks, the 6 way with 4 blanks and the 12 way with 12 blanks. The blanks are also available separately.

The flexible conduit fixing hole is slotted to aid cable installation. As the flexible conduit hole is part of the jack mounting metal work it ensures easy termination of the outlet while maintaining the cable management. The base has two fixing holes for mounting where required. The two parts of the box are assembled with a single machine screw.

GOP Boxes and "L" Brackets are sold in packs of 10 to reduce packaging waste. The flexible conduit is sold separately.

Product Specifications

Feature	Values
Surface mounted	Yes
Floor box/sub-floor mounted	Yes
Type of fastening	Screw
Suitable for number of outlets / modules	2

Product drawing (2-6 way versions)

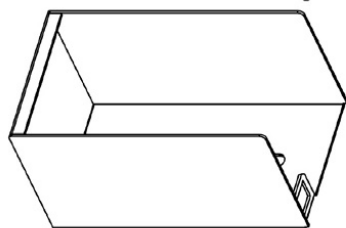
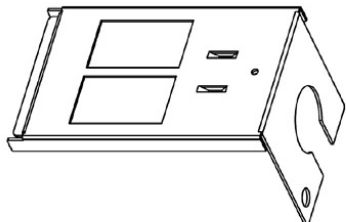

2 Way GOP Box Plus

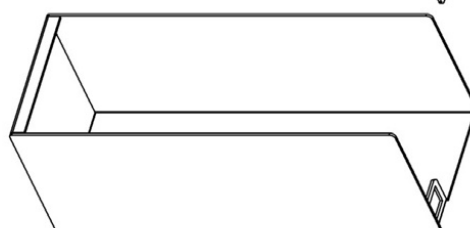
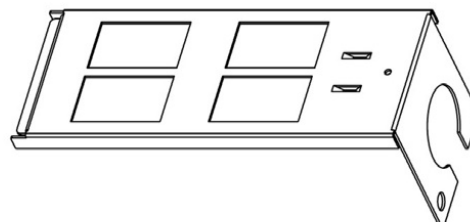

4 Way GOP Box Plus

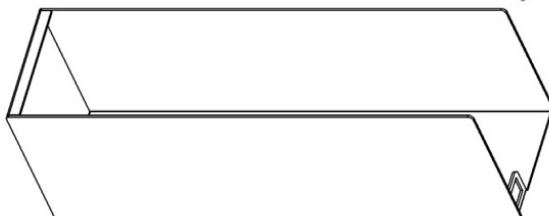
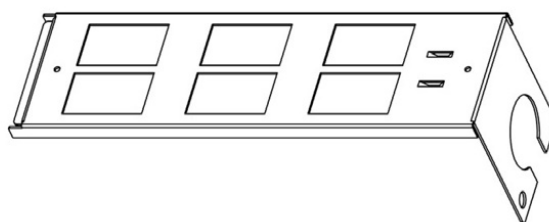

6 Way GOP Box Plus

Excel 2 Way GOP Box Plus 25mm (10-Pack)

Item Code: 350-639



Product drawing (2 way version)

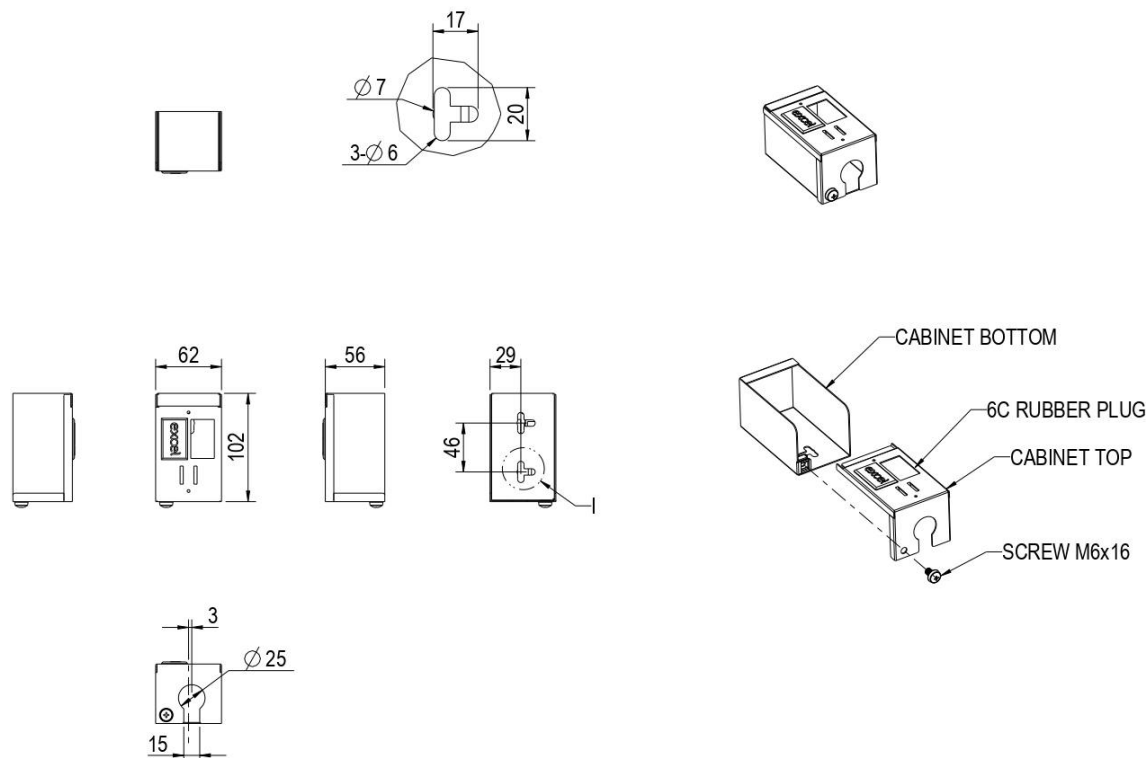

Standards

Applicable standard	Detail
RoHS	Compliant to the Restriction of Hazardous Substances
WFD	Compliant to Waste Framework Directive
SCIP	Compliant - Does Not Contain Substances of Concern in Products

Part Number Table

Part Number	Description
350-639	Excel 2 Way GOP Box Plus 25mm (10-Pack)

Excel is a world class premium performing end to end infrastructure solution designed, Manufactured, supported and delivered without compromise.

Contact us at sales@excel-networking.com



E&OE. Excel is a registered trade name of Mayflex Holdings Ltd.