



## Quality products *for the Built Environment*

Steel Conduit Tube,  
Accessories &  
Consumables

Steel Channel,  
Channel Nuts, Bracketry  
& Accessories

Switch & Socket Boxes,  
Adaptable Boxes &  
Accessories

Flexible Conduit Tube,  
Contractor Packs &  
Accessories

Flat Foot

PVC Conduit  
Accessories

Cable Accessories,  
Earthing & Wiring  
Products

Fixings &  
Fasteners

PRODUCT CATALOGUE 2024

metpro<sup>®</sup>

A metpro<sup>®</sup> Brand  
Group

Quality, value & innovation,  
in all that we do.



## Metpro Group: An Overview

Opening our doors in 1995, we supply exclusively to Electrical Wholesalers in order to bring the UK & Global construction markets the products they need, when they need them, as well as producing bespoke components for our OEM customers through our Demon Cato manufacturing service.



# Contents

All quantities shown throughout are inner box quantities only. For more information on our product ranges, service offering or for technical advice, please contact our sales team at any time.

## Steel Conduit Tube, Accessories & Consumables 06-19

Steel Conduit Tube	07-09
Malleable Boxes	10
Malleable Back Outlet Boxes	11
Malleable Extension Boxes	11
Saddles, Bends, Elbows & Tees	12-13
Couplers & Adaptors	14
Reducers & Stopping Plugs	14
Nipples	14
Miscellaneous Accessories	15
Steel & Brass	16-17
Specialist Tools & Consumables	18-19

## Channel Nuts, Bracketry & Accessories 20-30

Steel Channel	21
Threaded Rod & Connectors	22
Easyfit Channel Nut	23
Channel Spring Nuts	23
Square Plate Washers	24
Flat Brackets	24
90° Angle Brackets	25
Offset Angle Brackets	26
Z Profile & U Profile Brackets	26
Base Plates	27
Beam Clamps	28
Cantilever Arms	29
Channel Connectors	29
Tray & Trunking Hangers	30
Stand Off Brackets	30
Channel Accessories	30

## Switch & Socket Boxes, Adaptable Boxes & Accessories 32-35

Switch & Socket Boxes	33
Adaptable Boxes	34
PVC Dry Lining Boxes	35
PVC Surface Mounted Boxes	35
Accessories	35

## Flexible Conduit Tube, Accessories & Contractor Packs 36-38

PVC Contractor Packs	37
Glands	37
PVC Coated Steel Flexible Conduit Tube	38
Plain Steel Flexible Conduit Tube	38
PVC Flexible Conduit Tube	38

## Flat Foot 40-41

H Frame Kits	41
Eco Range	41

## PVC Conduit Accessories 42-45

Conduit Boxes	43
Saddles, Bends, Elbows & Tees	44
Couplers & Adaptors	44
Miscellaneous Accessories	45

## Cable Accessories, Earthing & Wiring Products 46-51

Cable Cleats	47
All Round Band	47
Earth Studs	47
PVC Insulation Tape	47
Earth Clamps	47
Brass Cable Gland Kits	48
Brass TRS Glands	48
PVC Dome Top Glands	49
PVC Stuffing Glands	49
Strip Connectors	49
Earth Blocks	49
Chapter 52® Fire Resistant Range	50-51

## Fixings & Fasteners 52-54

Hexagon Head Set Screws	53
Steel Hexagon Nuts	53
Hexagon Nut Caps	53
Top Hat Rod Caps	53
Steel Wedge Nuts	53
Brass Nuts	53
Brass Washers	53
Washers: Flat, Penny, Shakeproof,	
Red Fibre, Single Coil Spring	54
Non-Drill Anchors & Setting Tools	54
Roofing Bolts & Square Nuts	54

## Demon Cato 56-67

Conlok®	58-59
Rapid Saddle®	60-61
Rollatray®	62-63
Trunklip® & Trayklip®	64-65
Easyfit Channel Nuts	66-67

## About Metpro 68-73

Discover Metpro	68
Metpro Online	69
Quality Control	70
Our quality equipment	71
Major Projects: where you can find our products	72
CSR & industry involvement	73

## Technical Section 74-75

Ingress Protection (IP) Chart	74
British Standards	75
RoHS 2 Statement	75
CE & UKCA Marking	75

## Terms & Conditions 76-77



**A domestically carbon-neutral business, at Metpro Group we are actively committed to reducing our carbon footprint, working with Smart Carbon, our customers and the wider supply chain to understand and implement necessary changes for the future of our planet.**

**Conduit Tube**

*Page 07-09*

**Conduit Boxes**

*Pages 10-11*

**Saddles, Bends,  
Elbows & Tees**

*Pages 12-13*

**Couplers &  
Adaptors, Reducers  
& Stopping Plugs,  
Nipples**

*Page 14*

**Miscellaneous  
Accessories**

*Page 15*

**Steel &  
Brass**

*Pages 16-17*

**Specialist Tools &  
Consumables**

*Pages 18-19*

# Steel Conduit Tube, Accessories & Consumables

**Five Year Extended  
Warranty Available**

Contact us for full details

*Range accreditations*



UK Tested



LUL Authorised

Steel Conduit Tube, Accessories & Consumables

**Steel Conduit Tube:**  
Class 4 Hot Dip Galvanised

Our steel conduit tube is packed and shipped in inner and master bundles with all lengths supplied c/w one steel coupler and one plastic thread protection cap



Authorised for use on London Underground

In line with LU Standard 1-085 for use on surface and sub-surface locations



Compliant to BSEN61386-1:2008+A1:2019 & BS31 (where applicable)

Each length of our Class 4 steel conduit tube is ink jet marked:

**Metpro - (relevant standard) - Class 4 - 5557**



Class 4 Conduit Tube: BSEN61386-1:2008+A1:2019



Diameter	Length	Code	Lengths per bundle	Lengths per master bundle	Metres per master bundle
20mm*	3mtr	GC20/3	8	400	1200
25mm*	3mtr	GC25/3	8	320	960
20mm*	3.75mtr	GC20	8	400	1500
25mm*	3.75mtr	GC25	8	320	1200
32mm	3.75mtr	GC32	4	84	315
Hot dipped galvanised internally and externally			*UK tested		

Class 4 Conduit Tube (BS31)



Diameter	Length	Code	Lengths per bundle	Lengths per master bundle	Metres per master bundle
1.5"	3.75mtr	GC4	4	84	315
2"	3.75mtr	GC5	4	84	315
Hot dipped galvanised internally and externally					

Steel Conduit Tube, Accessories & Consumables

## Steel Conduit Tube: Pre-Galvanised & Black



Our steel conduit tube is packed and shipped in inner and master bundles with all lengths supplied c/w one steel coupler and one plastic thread protection cap

PLEASE NOTE: 32mm, 1.5", 2" and black enamel tube can be purchased & supplied as individual units (additional carriage charges may apply)



Authorised for use on London Underground\*

In line with LU Standard 1-085 for use on surface and sub-surface locations



Compliant to BSEN61386-1:2008+A1:2019\*

Each length of our Class 4 steel conduit tube is ink jet marked:

**Metpro - (relevant standard) - Class 4 - 5557**

**\*pre-galvanised steel conduit tube only**

### Pre-Galvanised Conduit Tube



Diameter	Length	Code	Lengths per bundle	Lengths per master bundle	Metres per master bundle
20mm	3mtr	GCP20/3	8	400	1200
25mm	3mtr	GCP25/3	8	320	960
20mm	3.75mtr	GCP20	8	400	1500
25mm	3.75mtr	GCP25	8	320	1200
Designed for indoor use			Manufactured from pre-galvanised sheet steel		

### Black Conduit Tube

Diameter	Length	Code	Lengths per bundle	Lengths per master bundle	Metres per master bundle
20mm	3.75mtr	BC20	8	160	600
25mm	3.75mtr	BC25	8	160	600
Designed for indoor use			Labelled: Metpro		



# Metpro® Mixed Master Bundle:

**20mm tube**  
x 200 lengths



**25mm tube**  
x 160 lengths

Each size individually wrapped & colour coded

Commit to only half a master bundle of each size

Half the stock at the same competitive price

Qualifying SKUs	
GC20/3	GCP20
GC25/3	GCP25
GC20	GCP20/3
GC25	GCP25/3

## How our steel conduit tube lengths are marked

Tube diameter

Batch number  
for simple traceability

British Standard  
assuring a quality product

Metpro logo  
for easy brand identification and our mark of quality

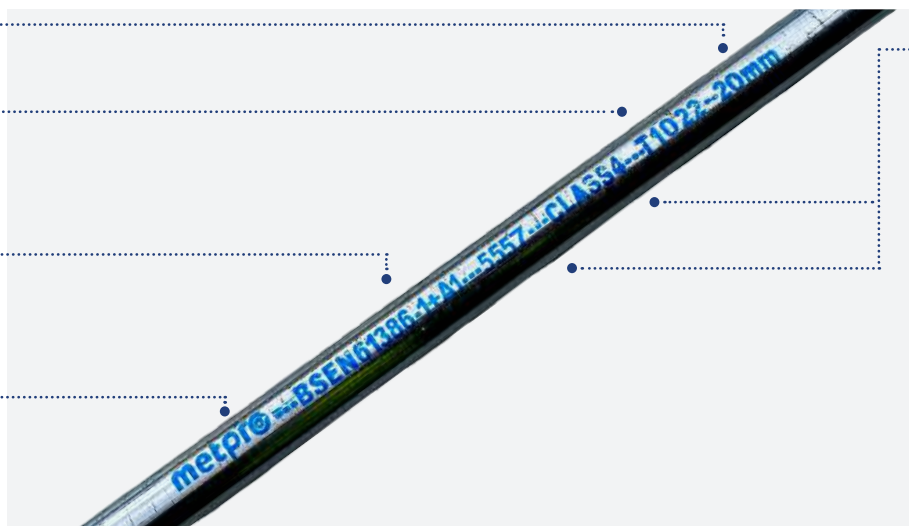

**BSEN61386-1:2008+AI:2019**  
Class Grades\*

- 5** Compression
- 5** Impact
- 5** Lower Temp. -45°C
- 7** Higher Temp. +400°C
- Class 4**

\*a requirement to meet this Standard

Steel Conduit Tube, Accessories & Consumables

## Malleable Boxes (Standard)

All Metpro malleable standard boxes, back outlet boxes and extension boxes are compliant to BSEN61386-1:2008+A1:2019, available in galvanised or black enamel finishes and supplied c/w M4 tapped hole in base for earthing screw

PLEASE NOTE: All black enamel products can be purchased & supplied as individual units

### Terminal



Size	Galv	Black	Pack
20mm	MB1G	MB1B	10
25mm	MB8G	MB8B	10
32mm	MB21G	-	1



### Branch U



Size	Galv	Black	Pack
20mm	MB6G	MB6B	10
25mm	MB13G	MB13B	10



### Through



Size	Galv	Black	Pack
20mm	MB2G	MB2B	10
25mm	MB9G	MB9B	10
32mm	MB22G	-	1



### Branch Y



Size	Galv	Black	Pack
20mm	MB7G	MB7B	10
25mm	MB14G	MB14B	10



### Angle



Size	Galv	Black	Pack
20mm	MB3G	MB3B	10
25mm	MB10G	MB10B	10
32mm	MB23G	-	1



### Through H



Size	Galv	Black	Pack
20mm	MB15G	MB15B	10
25mm	MB16G	-	10



### Tee



Size	Galv	Black	Pack
20mm	MB4G	MB4B	10
25mm	MB11G	MB11B	10
32mm	MB24G	-	1



### Tangent Tee



Size	Galv	Black	Pack
20mm	MB17G	MB17B	10



### Intersection



Size	Galv	Black	Pack
20mm	MB5G	MB5B	10
25mm	MB12G	MB12B	10



### Tangent Angle



Size	Galv	Black	Pack
20mm	MB19G	MB19B	10



Steel Conduit Tube, Accessories & Consumables

## Malleable Back Outlet & Extension Boxes

Offering enhanced corrosion resistance and a more aesthetically pleasing and shiny finish, our malleable boxes receive an additional zinc coating following the hot dip galvanising process. All boxes are Metpro branded for easy identification and confidence of a quality product

PLEASE NOTE: All black enamel products can be purchased & supplied as individual units

### Back Outlet



Size	Galv	Black	Pack
20mm	TB1G	TB1B	10
25mm	TB1IG	-	10



### Terminal Back Outlet



Size	Galv	Black	Pack
20mm	TB2G	TB2B	10



### Through Back Outlet



Size	Galv	Black	Pack
20mm	TB3G	TB3B	10



### Angle Back Outlet



Size	Galv	Black	Pack
20mm	TB4G	TB4B	10



### Tee Back Outlet



Size	Galv	Black	Pack
20mm	TB5G	TB5B	10



### Intersection Back Outlet



Size	Galv	Black	Pack
20mm	TB6G	TB6B	10



### Terminal



Size	Galv	Black	Pack
20mm	ET1G	ET1B	10



### Through



Size	Galv	Black	Pack
20mm	ET2G	ET2B	10



### Angle



Size	Galv	Black	Pack
20mm	ET3G	ET3B	10



### Tee



Size	Galv	Black	Pack
20mm	ET4G	ET4B	10



### Intersection



Size	Galv	Black	Pack
20mm	ET5G	ET5B	10



Steel Conduit Tube, Accessories & Consumables

## Saddles; Spacer Bar, Plain, Distance, Hospital & Half

All Metpro steel saddles have been manufactured in accordance with BSEN61386-1:2008+A1:2019 & BS 31 where applicable, and are authorised for use on London Underground in surface and sub-surface locations as compliant to LU Standard 1-085

### Spacer Bar Saddles



Size	Galv	Black	Pack
20mm	SBS20G	SBS20BL	100
25mm	SBS25G	SBS25BL	100
32mm	SBS32G	SBS32B	50
1.5"	SBS38G	SBS38B	50
2"	SBS50G	SBS50B	25



### Hospital Saddles



Size	Galv	Black	Pack
20mm	HOSPIG	-	25
25mm	HOSP2G	-	20



### Plain Saddles



Size	Galv	Black	Pack
20mm	PSIG	PSIB	100
25mm	PS2G	PS2B	100
32mm	PS3G	PS3B	100
1.5"	PS4G	PS4B	50
2"	PS5G	PS5B	50



### Half Saddles



Size	Galv	Black	Pack
20mm	HS1G	HS1B	100
25mm	HS2G	HS2B	100



### Distance Saddles



Size	Galv	Black	Pack
20mm	DSIG	DSIB	50
25mm	DS2G	DS2B	50
32mm	DS3G	DS3B	25
1.5"	DS4G	DS4B	25
2"	DS5G	DS5B	10



Steel Conduit Tube, Accessories & Consumables

## Bends, Elbows & Tees

All Metpro bends, elbows & tees have been manufactured in accordance with BSEN61386-1:2008+A1:2019 & BS 31 where applicable, and are authorised for use on London Underground in surface and sub-surface locations as compliant to LU Standard I-085

PLEASE NOTE: All black enamel products can be purchased & supplied as individual units

### Solid Bend



Size	Galv	Black	Pack
20mm	SB1G	SB1B	10
25mm	SB2G	SB2B	10
32mm	SB3G	-	1



### Solid Tee



Size	Galv	Black	Pack
20mm	ST1G	-	10
25mm	ST2G	-	10



### Inspection Bend



Size	Galv	Black	Pack
20mm	IB1G	IB1B	10
25mm	IB2G	IB2B	10
32mm	IB3G	-	1



### Inspection Tee



Size	Galv	Black	Pack
20mm	IT1G	IT1B	10
25mm	IT2G	IT2B	10
32mm	IT3G	-	1



### Solid Elbow



Size	Galv	Black	Pack
20mm	SE1G	-	10
25mm	SE2G	-	10



### Inspection Elbow



Size	Galv	Black	Pack
20mm	IE1G	IE1B	10
25mm	IE2G	IE2B	10
32mm	IE3G	-	1



Steel Conduit Tube, Accessories & Consumables

## Couplers & Adaptors, Reducers & Stopping Plugs, Nipples

All Metpro steel couplers & adaptors, reducers & stopping plugs and nipples have been manufactured in accordance with BSEN61386-1:2008+A1:2019 & BS 31 where applicable, and are authorised for use on London Underground as compliant to LU Standard I-085

PLEASE NOTE: All black enamel products can be purchased & supplied as individual units

### Solid Couplers



Size	Galv	Black	Pack
20mm	SC1G	SC1B	100
25mm	SC2G	SC2B	50
32mm	SC3G	SC3B	50
1.5"	SC4G	SC4B	25
2"	SC5G	SC5B	10
63mm	SC6G	-	1
75mm	SC8G	-	1



### Imperial to Metric Adaptor



Size	Galv	Black	Pack
3/4" (M) to 20mm (F)	FA2G	FA2B	100
1" (M) to 25mm (F)	FA4G	FA4B	10



### Flanged Couplers



Size	Galv	Black	Pack
20mm	FCS1G*	FCS1B	50
25mm	FCS2G*	FCS2B	25
32mm	FCS3G**	-	10



\*HDG finish

\*\* BZP finish

### Hexagon Reducers



Size	Galv	Black	Pack
20-16mm	HR1G	HR1B	50
25-20mm	HR2G	HR2B	50
32-20mm	HR3G	HR3B	25
32-25mm	HR4G	HR4B	25



### Hexagon Stopping Plugs



Size	Galv	Black	Pack
20mm	HSP1G	HSP1B	50
25mm	HSP2G	HSP2B	25
32mm	HSP3G	-	25



### Earth Couplers



Size	Galv	Black	Pack
20mm	EC1G	EC1B	100
25mm	EC2G	EC2B	50



### Screwed Nipples



Size	Code	Pack
20mm short	NS1	100
20mm long*	NS1/L	10
25mm short	NS2	100
25mm long*	NS2/L	10
32mm short	NS3	25



All nipples are BZP finish

\*Long nipples are 300mm length

### Metric to Imperial Adaptor



Size	Galv	Black	Pack
20mm (M) to 3/4" (F)	FA1G	FA1B	100
25mm (M) to 1" (F)	FA3G	FA3B	10



Steel Conduit Tube, Accessories & Consumables

## Miscellaneous Accessories

All Metpro steel miscellaneous conduit accessories are manufactured in accordance with BSEN61386-1:2008+A1:2019 and are authorised for use on London Underground and compliant to LU Standard 1-085 (excludes rubber gaskets)

PLEASE NOTE: All black enamel products can be purchased & supplied as individual units

### Extension Rings

mm>>	10mm	13mm	16mm	20mm	25mm	32mm	40mm	50mm
Galv	SRI0G*	SRI3G*	SRI6G*	SR20G**	SR25G**	SR32G**	SR40G**	SR50G***
Black	SRI0B*	SRI3B*	SRI6B*	SR20B**	SR25B**	SR32B**	SR40B**	SR50B***

Pack quantities: \*50 / \*\*20 / \*\*\*10



### Loop-in Boxes

Size	Galv	Black	Pack
1 hole	LPIG	LPIB	10
1 hole (25mm KO)	LPIG/25	-	10
2 hole	LP2G	-	10
4 hole k/o	LP4G	LP4B	10
1 hole malleable	MLPIG	-	10



### Ball & Socket Cover

Code	Pack
BSCIG	20

Manufactured from malleable iron



### Box Lids/Covers

Type	Galv	Black	Pack
circular	BL1G	BL1B	100
oversized	BL1G/OS	-	50
4 hole*	BL3G	-	1
heavy**	HL1G	-	50

\*Suits 32mm conduit boxes  
\*\*Manufactured from 2mm thick mild steel



### Male Hooks

Size	Galv	Black	Pack
20mm	MH1G	MH1B	25
20mm	MHM1G*	MHM1B*	50

\*Manufactured from malleable iron



### Dome Covers: Female

Size	Galv	Black	Pack
20mm	DC1G	DC1B	25
20mm	MDC1G*	-	20
25mm	DC2G	-	25

\*Manufactured from malleable iron



### Rubber Gaskets

Type	Code	Pack
gaskets	CRG1	100
4 hole circular	CRG3	1



### Hook Plates

Size	Galv	Black	Pack
20mm	HPIG	HPIB	25



### Crampets

Size	Type	Galv	Black	Pack
20mm	Flat	CF1G	CF1B	100
25mm	Flat	CF2G	CF2B	100
20mm	Twisted	CF1G/T	CF1B/T	100
25mm	Twisted	CF2G/T	CF2B/T	100



Steel Conduit Tube, Accessories & Consumables

## Steel & Brass

We offer the full range of steel & brass fixings for use with steel conduit tube, all manufactured in accordance with BSEN61386-1:2008+A1:2019 & BS 31 where applicable

### Male Brass Bushes: Short

Size	Code	Pack
16mm	MBBS16	100
20mm	MBBS1	100
25mm	MBBS2	100
32mm	MBBS3	50
1.5"	MBBS4	50
2"	MBBS5	25



### Brass Lock Rings

Size	Code	Pack
63mm	LR6	1
2.5"	LR7	1
75mm	LR8	1
3"	LR9	1



All brass lock rings are manufactured with a milled edge

### Male Brass Bushes: Long

Size	Code	Pack
20mm	MBBL1	100
25mm	MBBL2	100
32mm	MBBL3	50
1.5"	MBBL4	20
2"	MBBL5	10
63mm	MBBL6	1
2.5"	MBBL7	1
75mm	MBBL8	1
3"	MBBL9	1



### Box Lid Screws

Size	Code	Pack
M4 x 6mm	BM6	100
M4 x 10mm	BM10	100
M4 x 12mm	BM12	100
M4 x 16mm	BM16	100
M4 x 20mm	BM20	100
M4 x 25mm	BM25	100
M4 x 30mm	BM30	100
M4 x 35mm	BM35	100
M4 x 40mm	BM40	100
M4 x 50mm	BM50	100



All box lid screws are pan head

### Female Brass Bushes

Size	Code	Pack
20mm	FBB1	100
25mm	FBB2	100
32mm	FBB3	100
1.5"	FBB4	100
2"	FBB5	25
63mm	FBB6	1
2.5"	FBB7	1
75mm	FBB8	1
3"	FBB9	1



### Brass Slotted Plugs

Size	Code	Pack
20mm	BSP1	100
25mm	BSP2	100





Steel Conduit Tube, Accessories & Consumables

## Steel & Brass

Metpro steel fixings are authorised for use on London Underground as compliant to LU Standard I-085 and manufactured in accordance with BSEN61386-1:2008+A1:2019 & BS 31 where applicable

PLEASE NOTE: All black enamel products can be purchased & supplied as individual units.

### Locknuts



Size	Galv	Black	Pack
16mm	LN16G	-	100
20mm	LN1G	LN1B	100
25mm	LN2G	LN2B	100
32mm	LN3G	LN3B	100
40mm	LN40G	-	50
1.5"	LN4G	LN4B	50
2"	LN5G	LN5B	50
20mm heavy*	HN1G	-	100

\*Manufactured from 4.4mm steel



*One of my installer customers contacted Metpro directly for some urgent technical advice on loadings of specific products. Metpro contacted me and advised of the request, then sent the information by email within minutes.*

*Metpro stockist, North East England*

### Lock Rings



Size	Code	Pack
16mm	LR16	100
20mm	LR1	100
25mm	LR2	100
32mm	LR3	100
1.5"	LR4	50
2"	LR5	50

Manufactured from steel with milled edge's and BZP finish



Steel Conduit Tube, Accessories & Consumables

We offer a range of specialist products for use in conjunction with our steel conduit tube and accessories range

## Specialist Tools & Consumables

### Conduit Tube Bending Machine

Code	Pack
BM20/25	1

Portable stand machine with dual sized former to handle 20 & 25mm tube  
 Creates accurate bends every time by a simple adjustment to the former  
 Can produce complex, multiple bends quickly  
 Comes c/w 20 & 25mm formers as standard

### Conduit Tube Bending Machine

Code	Description	1Pack
BMSPV	Pipe Vice	1
BMSF20	20mm Former	1
BMSF25	25mm Former	1
BMSF32	32mm Former	1
BMSGR	Grooved Roller	1
BENROL	Grooved Roller Pin	1
BMSCP	Former Pin	1
BENJAW	Pipe Vice Jaws	1
BENRP	Stop Bar Holder	1
BMSLP	Lock Pin	1
BENSB	Tube Stop Bar	1
BMSSPC	Spring Clip Pin	1
BMSSF	Stop Fitting	1



Steel Conduit Tube, Accessories & Consumables

## Specialist Tools & Consumables

### Stock & Die Set

For Conduit Size	Code	Pack
20-25mm	SAD1	1
32mm	SAD2	1

For threading conduit on-site

Supplied c/w high quality steel dies and guides

SAD1 contains:  
1 x die stock, 1 x 20mm die, 1 x 25mm die,  
1 x 20mm guide, 1 x 25mm guide,  
carry case

SAD2 contains:  
1 x die stock, 1 x 32mm die,  
1 x 32mm guide



### Stock & Die Set: Spares

Size & Type	Code	Pack
20mm die	SAD1/20SD	1
25mm die	SAD1/25SD	1
20mm guide	SAD1/20SG	1
25mm guide	SAD1/25SG	1
die stock	SAD1/DS	1



### Conduit Threading Tallow

Size	Code	Pack
500g block	TALLOW	1



### Metal Cutting Lubricant

Size	Code	Pack
450g tin	TEMAXOL	1



### Universal Bush Spanner

Code	Pack
BKSI	1

Specifically designed for installation of male brass bushes

Saves time on installation

Suits 20 & 25mm bushes and fits inside body bore to prevent slippage



### Draw Tape

Size (length)	Code	Pack
20mtr	PDT1	1

Manufactured from 3mm nylon cord and c/w brass looped ends



### Jack Chain

Type	Galv	Black	Pack
no.8	JC0	JCOB	1
no.10	JC1	JCIB	1

\*1 pack = 10mtr length

No.8 chain nominal material thickness of 4mm

No.10 chain nominal material thickness of 3mm



**Steel Channel**

*Page 21*

**Threaded Rod &  
Connectors**

*Pages 22*

**Easyfit Channel Nut,  
Channel Spring Nuts**

*Pages 23*

**Square Plate  
Washers,  
Flat Brackets**

*Pages 24*

**90° Angle Brackets**

*Page 25*

**Offset Angle  
Brackets, Z & U  
Profile Brackets**

*Pages 26*

**Base Plates**

*Page 27*

**Beam Clamps**

*Pages 28*

**Cantilever Arms**

*Pages 29*

**Channel Connectors**

*Pages 29*

**Tray & Trunking  
Hangers**

*Pages 30*

**Stand Off Brackets**

*Pages 30*

**Channel Accessories**

*Pages 30*

# Steel Channel, Bracketry & Accessories

*Range accreditations*



UK Tested



LUL Authorised

**Five Year Extended  
Warranty Available**

Contact us for full details

Channel Nuts, Bracketry & Accessories

## Steel Channel

**Offering only the highest quality product, our steel channel options are all fully compliant to BS6946:1988.**

The Metpro brand is stamped frequently along each length for full traceability, right back to the raw material certification.



Meets the mechanical strength of BS6946

Our raw material is controlled to ensure a 250MPa minimum yield strength



Compliant to BSEN10346

Our steel channel lengths feature a pre-galvanised Z275 finish (275g galv per Mtr<sup>2</sup>)

### Steel Channel: Heavy Gauge

SKU	Description	Qty
MPC1/3	41 x 41mm / 3mtr Plain: Heavy Gauge	50
MPC2/3	41 x 41mm / 3mtr Slotted: Heavy Gauge	50
MPC6/3	41 x 21mm / 3mtr Plain: Heavy Gauge	50
MPC7/3	41 x 21mm / 3mtr Slotted: Heavy Gauge	50
MPC1/6	41 x 41mm / 6mtr Plain: Heavy Gauge	50
MPC2/6	41 x 41mm / 6mtr Slotted: Heavy Gauge	50
MPC6/6	41 x 21mm / 6mtr Plain: Heavy Gauge	50
MPC7/6	41 x 21mm / 6mtr Slotted: Heavy Gauge	50
Manufactured from 2.5mm thick material		

Comprising both heavy gauge and light gauge, all our lengths are marked 'Metpro' and comply with BS6946.



### Steel Channel: Light Gauge

SKU	Description	Qty
MPC3/3	41 x 41mm / 3mtr Plain: Light Gauge	50
MPC4/3	41 x 41mm / 3mtr Slotted: Light Gauge	50
MPC8/3	41 x 21mm / 3mtr Plain: Light Gauge	50
MPC9/3	41 x 21mm / 3mtr Slotted: Light Gauge	50
Manufactured from 1.5mm thick material		

### Steel Channel Cover Strips

SKU	Description	Qty
MCS/W	PVC Steel Channel Cover Strip - 3mtr: White	25
MCS/B	PVC Steel Channel Cover Strip - 3mtr: Black	25

Channel Nuts, Bracketry & Accessories

## Threaded Rod & Connectors

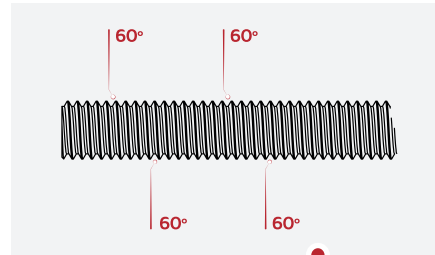

In line with DIN334, our threaded rod connectors also feature a 60° thread, enhancing the strength and reliability of our product when used together.

### 60 degrees of perfection

Manufactured with a consistent 60° angle thread on each length, a **must** in order to meet DIN976, Metpro threaded rod is fully compliant to this latest (DIN975 has now been superseded by 976).

Ensuring optimum contact between the rod and mating nut, this 60° pitch not only provides a solid and strong load bearing connection, but also features thicker material on the threads, further reinforcing the strength of our product and a fully installed system.



### Manufactured from 4.8 grade steel

Ensuring the required mechanical strength of DIN Standard 976



### Fully RoHS2 compliant

Offering a clean, safe product for the industry

#### Threaded Rod

SKU	Description	Qty
TR6	M6 x 3mtr Threaded Rod - BZP	50
TR8	M8 x 3mtr Threaded Rod - BZP	25
TR10	M10 x 3mtr Threaded Rod - BZP	20
TR12	M12 x 3mtr Threaded Rod - BZP	10

#### Threaded Rod Connectors

SKU	Description	Qty
TRC6	M6 x 18mm Threaded Rod Connector - BZP	100
TRC8	M8 x 24mm Threaded Rod Connector - BZP	100
TRC10	M10 x 30mm Threaded Rod Connector - BZP	100
TRC12	M12 x 36mm Threaded Rod Connector - BZP	100

Channel Nuts, Bracketry & Accessories

## Easyfit Channel Nuts, Channel Spring Nuts

### Easyfit Channel Nut



Size	Code	Pack
M6	CN6	100
M8	CN8	100
M10	CN10	100
M12	CN12	100

Steel nut is BZP finish  
Easyfit cone manufactured from nylon 6



### How Easyfit Channel Nuts work



1. Place in strut
2. Turn clockwise 90°
3. Secured and ready

### Saves up to 30%

Installation time when compared with traditional spring nuts and fits all standard strut depths

### Only four sizes to stock

One size fits all standard strut depths

### One-handed installation

Designed for the contractor, finger grips within the nylon cone make installation easy

### Slide & hold

No springs allow for smooth positioning within both standard and slotted strut with the easyfit's non-slip cone holding the nut in place, even on vertical channel

### Exclusive to Metpro

The Easyfit Channel Nut is only available from Metpro throughout the UK & Europe

The Easyfit Channel Nut and our channel spring nuts range are compliant to BS6946 (nut only) and UK tested for complete confidence

Our plain channel nuts, short spring nuts and long spring nuts are also authorised for use by London Underground as compliant to LU Standard I-085

### Plain Channel Nuts



Size	Zinc Plated	HDG*	316 Stainless Steel**	Pack
M6	CS20	CS20/GA	CS20/SS	100
M8	CS21	CS21/GA	CS21/SS	100
M10	CS22	CS22/GA	CS22/SS	100
M12	CS23	CS23/GA	CS23/SS	100

\*Hot Dip Galvanised  
\*\*Material Grade for body

### Short Spring Nuts



Size	Zinc Plated	HDG*	316 Stainless Steel**	Pack
M6	CS24	CS24/GA	CS24/SS	100
M8	CS25	CS25/GA	CS25/SS	100
M10	CS26	CS26/GA	CS26/SS	100
M12	CS27	CS27/GA	CS27/SS	100

\*Hot Dip Galvanised  
\*\*Material Grade for both body and spring

### Long Spring Nuts



Size	Zinc Plated	HDG*	316 Stainless Steel**	Pack
M6	CS28	CS28/GA	CS28/SS	100
M8	CS29	CS29/GA	CS29/SS	100
M10	CS30	CS30/GA	CS30/SS	100
M12	CS31	CS31/GA	CS31/SS	100

\*Hot Dip Galvanised  
\*\*Material Grade for both body and spring



Channel Nuts, Bracketry & Accessories

## Square Plate Washers, Flat Brackets

Our square plate washers and flat brackets are compliant to BS6946 and authorised for use by London Underground as compliant to LU Standard 1-085

### Square Plate Washers



Type	Code	Pack
square plate washer M6	MPI/6	100
square plate washer M8	MPI/8	100
square plate washer M10	MPI/10	100
square plate washer M12	MPI/12	100

All square plate washers are HDG finish



### Flat Brackets



Type	Code	Pack
splice plate 2 hole	MP2	50
splice plate 3 hole	MP3	25
splice plate 4 hole	MP4	50
splice plate 5 hole	MP5	25
flat L bracket	MP6	25
flat T bracket	MP7	25
crossover bracket	MP55	25

All flat brackets are HDG finish



MP2

MP3

MP4



MP5

MP6

MP7



MP55



Channel Nuts, Bracketry & Accessories

## 90° Angle Brackets

Our 90° angle brackets are compliant to BS6946 and authorised for use by London Underground as compliant to LU Standard 1-085

### 90° Angle Brackets



Type	Code	Pack
1 + 1 hole 90° bracket	MP8	100
1 + 2 hole 90° bracket	MP9	25
1 + 3 hole 90° bracket	MP10	25
2 + 2 hole 90° bracket	MP11	25
2 + 1 hole 90° bracket	MP12	25
LHT corner bracket	MP13	25
RHT corner bracket	MP14	25
90° T bracket	MP15	25
4 hole 90° bracket	MP17	10
3 hole 90° bracket	MP18	25
2 + 2 hole gusset shelf bracket	MP19	10

All 90° angle brackets are HDG finish



MP8



MP9



MP10



MP11



MP12



MP13



MP14



MP15



MP17



MP18



MP19

Channel Nuts, Bracketry & Accessories

## Offset Angle Brackets, Z & U Profile Brackets

Our offset angle brackets and Z & U profile brackets are compliant to BS6946 and authorised for use by London Underground as compliant to LU Standard I-085

### Offset Angle Brackets



Type	Code	Pack
45° T bracket	MP16	25
45° obtuse angle bracket	MP20	25
22.5° obtuse angle bracket	MP21*	50
15° obtuse angle bracket	MP22*	50
45° acute angle bracket	MP23	25
2 + 2 hole hinged angle bracket	MP57*	10

All offset angle brackets are HDG finish  
\*Can be purchased individually

### Z Profile & U Profile Brackets



Type	Code	Pack
21mm Z bracket	MP24	25
41mm Z bracket	MP25	25
82mm Z bracket	MP26	25
channel jointing bracket	MP27	25
21mm U bracket	MP28	25
41mm U bracket	MP29	10
82mm U bracket	MP30	10
side by side U bracket	MP31	10
2 lug wing bracket	MP32	10

All Z profile & U profile brackets are HDG finish

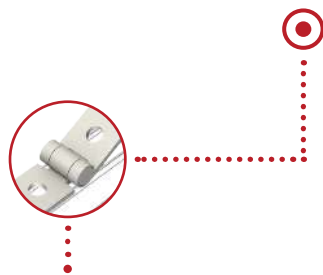

#### Centralised Hinge

Our 2+2 hole hinged angle bracket offers unlimited flexibility through its central hinge allowing for any angle to be set

Channel Nuts, Bracketry & Accessories

Our base plates are compliant to BS6946 and authorised for use by London Underground as compliant to LU Standard 1-085

## Base Plates

### Base Plates



Type	Code	Pack
single lug channel base plate	MP33	5
double lug channel base plate	MP34	25
double channel base plate	MP35	5
single channel gusset base plate	MP36	1
double channel gusset plate	MP37	1

All base plates are HDG finish

*Every time we won a major tender to supply cable management products I would look for ways to source my accessories quickly, in full, and on time. Fortunately, now I have found Metpro I no longer worry as they hold comprehensive stock and are able to be flexible in their delivery.*

*Metpro stockist, Berkshire*



MP33



MP34



MP35



MP36



MP37

Channel Nuts, Bracketry & Accessories

## Beam Clamps

### Miscellaneous Beam Clamps



Type	Code	Pack
toe beam clamp c/w Ø14mm blind hole	MP38	50
large C clamp c/w 8.8 HT cone point	MP39	25
small C clamp c/w 8.8 HT cone point	MP40	50
Z clamp c/w 8.8 HT cone point	MP41	50

All miscellaneous beam clamps are HDG finish with BZP fixings (where applicable)



MP38



MP39



MP40



MP41

### Window Beam Clamps



Type	Code	Pack
21mm c/w 8.8 HT cone point	MP42/21	10
41mm c/w 8.8 HT cone point	MP42/41	10
82mm c/w 8.8 HT cone point	MP42/82	10

All window beam clamps are HDG finish with BZP fixings



MP42/21



MP42/41



MP42/82

Our beam clamps are compliant to BS6946 and authorised for use by London Underground as compliant to LU Standard I-085 (for use on surface and sub-surface locations)

### U Bolt Beam Clamps



Size	Code	Pack
41mm c/w M10 nuts & washers	MP43/41/10	10
82mm c/w M10 nuts & washers	MP43/82/10	10

All U bolt beam clamps are HDG finish with BZP fixings



MP43/41/10



MP43/82/10

### G Clamps (for fixed beams)



Size	Code	Pack
M6 G clamp c/w 8.8 HT M6 bolt & nut	MP44/6	50
M8 G clamp c/w 8.8 HT M8 bolt & nut	MP44/8	25
M10 G clamp c/w 8.8 HT M10 bolt & nut	MP44/10	25

All G clamps are HDG finish with BZP fixings



MP44/6



MP44/8



MP44/10

### Internal Beam Clamp Kit

Size	Code	Pack
Standard	MP58	10

HDG finish and supplied c/w 2 x M10x40mm Cone Point Screws



Channel Nuts, Bracketry & Accessories

## Cantilever Arms, Channel Connectors

All Metpro cantilever arms and channel connectors are compliant to BS6946 and authorised for use on London Underground to LU Standard 1-085 (for use on surface & sub-surface locations)

### Cantilever Arms



Size	Code	Pack
150mm	MP521	10
300mm	MP522	10
450mm	MP523	10
600mm	MP524	10
750mm	MP525	10
900mm	MP526	10
1000mm	MP527	10

HDG finish

\*All cantilever arms available to order in singles



### Channel Connectors



Size	Code	Pack
21mm internal	MP47/21	20
41mm internal	MP47/41	10
21mm external	MP48/21	10
41mm external	MP48/41	10

Internal channel connectors supplied c/w screws

Internal connectors - BZP finish

External connectors - HDG finish



### Slotted Cantilever Arms



Size	Code	Pack
150mm	MP521/SL	10
300mm	MP522/SL	10
450mm	MP523/SL	10
600mm	MP524/SL	10
750mm	MP525/SL	10
900mm	MP526/SL	10
1000mm	MP527/SL	10

HDG finish

\*All cantilever arms available to order in singles

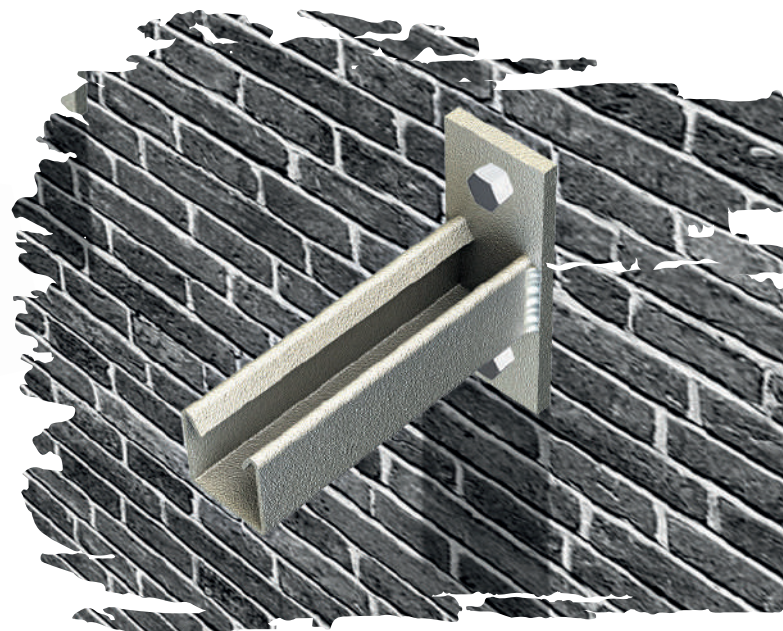

Channel Nuts, Bracketry & Accessories

## Stand-Off Brackets, Tray & Trunking Hangers, Accessories

Our stand off brackets, tray & trunking and channel support accessories are compliant to LU Standard 1-085 (with the exception of end caps)

### Stand Off Brackets



Size	Code	No. Slots	No. Nuts Per Slot	Pack
50mm	THB50	1	1	50
75mm	THB75	1	1	50
100mm	THB100	1	2	50
150mm	THB150	1	2	50
225mm	THB225	2	2	20
300mm	THB300	2	2	20
-	THB/M6	(spare captive nut)		100

Captive nut dramatically reduces installation time & slides along bracket length allowing easy adjustment of fixing point location

Standard M6 roofing bolt used for direct installation into captive nut

Suitable for the installation of light, medium or heavy duty cable tray and basket  
BZP finish



### Tray & Trunking Hangers



Size	Code	Pack
100mm	TTH100	20
150mm	TTH150	20
225mm	TTH225	20
300mm	TTH300	20

Accepts both tray & trunking on same hanger - multiple or single fixing points on all sizes

Pre-galvanised finish



### Cone Point: HT8.8



Size	Code	Pack
M10 x 40mm	CP1040	100

Manufactured from High Tensile steel Grade 8.8  
BZP finish



### Suspension Unit



Code	Pack
MP46	100

Zinc die cast - BZP finish (plate & nut)  
\*Can be purchased individually



### Purlin Clip



Code	Pack
MP45	100

BZP finish



### PVC End Caps

41x41mm	41x21mm	Pack
MP50/W	MP51/W	100
MP50/B	MP51/B	100



As part of our Demon Cato innovations capabilities and bespoke manufacturing offering, we are able to offer rapid prototyping using the latest digital software and our state-of-the-art in-house 3D printer

Image: Grand Lee, Senior Engineer



**Switch & Socket  
Boxes**

*Page 33*

**Adaptable Boxes**

*Pages 34*

**PVC Dry Lining  
Boxes**

*Pages 35*

**PVC Surface  
Mounted Boxes**

*Page 35*

**Accessories**

*Pages 35*

# Switch & Socket Boxes, Adaptable Boxes & Accessories

*Range accreditations*



UK Tested



LUL Authorised



Switch & Socket Boxes, Adaptable Boxes & Accessories

## Switch & Socket Boxes

Metpro switch & socket boxes are manufactured from 0.9mm pre-galvanised sheet steel with compliance to BS4662 and authorised for use by London Underground to LU Standard 1-085 (for use on surface and sub-surface locations)



Authorised for use on London Underground



Manufactured and compliant to BS4662

### Flush Back Boxes



Size (depth)	No. Gangs	Code	Fixed Lugs	No. Adjustable Lugs	Pack
16mm	1	EWS1	1	1	20
25mm	1	EWS2	3	1	10
25mm	2	EWS3	1	1	5
35mm	1	EWS4*	3	1	10
35mm	2	EWS5*	1	1	5
35mm	dual box	EWS6*	6	2	5
25mm	dual box	EWS6/25	6	2	5
47mm	1	EWS7*	3	1	10
47mm	2	EWS8*	1	1	5

All flush back boxes supplied with 20mm knockouts (\*and 25mm knockouts) excluding EWS1

### Extension Boxes



Size (depth)	No. Gangs	Code	Fixed Lugs	No. Adjustable Lugs	Pack
16mm	1	EWS9	1	1	20
16mm	2	EWS10	1	1	10
25mm	1	EWS11	3	1	10
25mm	2	EWS12	1	1	5
35mm	1	EWS13	3	1	10
35mm	2	EWS14	1	1	5



Switch &amp; Socket Boxes, Adaptable Boxes &amp; Accessories

## Adaptable Boxes

All Metpro adaptable boxes are manufactured from pre-galvanised steel and comprise of body, flanged cover and 4 x steel lid fixing screws

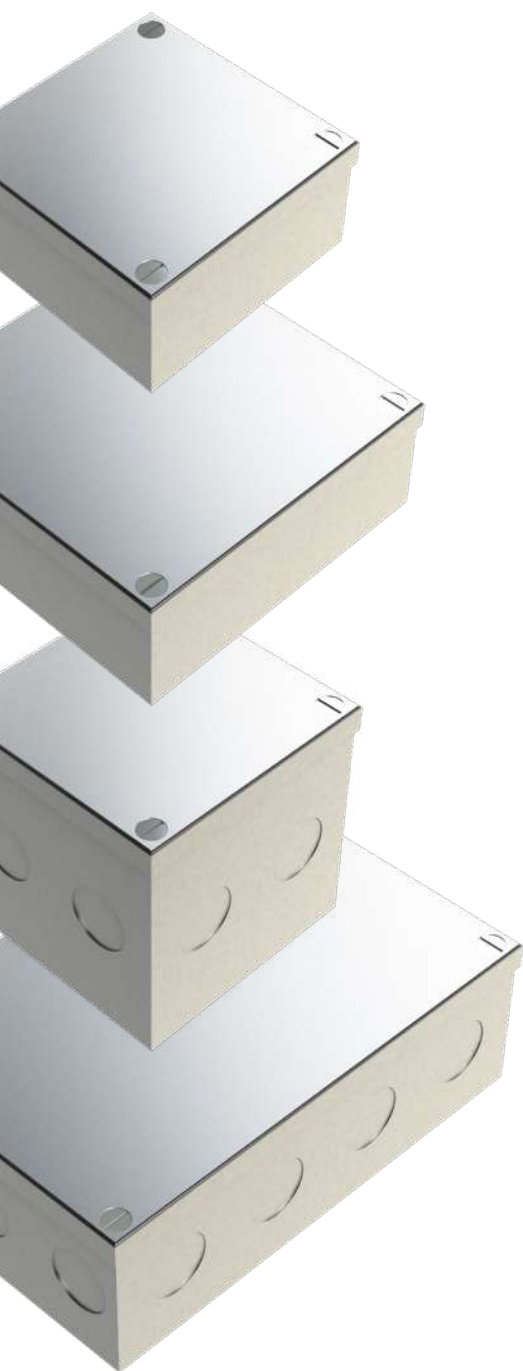

### Adaptable Boxes



Size (metric)	Size (imperial approximate)	Code (plain)	Code (knockouts)	Pack
75 x 75 x 37.5	(3 x 3 x 1.5")	AB01G	AB01G/K	10
75 x 75 x 50	(3 x 3 x 2")	AB02G	AB02G/K	10
75 x 75 x 75	(3 x 3 x 3")	AB03G	AB03G/K	5
100 x 100 x 37.5	(4 x 4 x 1.5")	AB04G	AB04G/K	5
100 x 100 x 50	(4 x 4 x 2")	AB05G	AB05G/K	5
100 x 100 x 75	(4 x 4 x 3")	AB06G	AB06G/K	5
100 x 100 x 100	(4 x 4 x 4")	AB07G	AB07G/K	2
150 x 75 x 50	(6 x 3 x 2")	AB08G	AB08G/K	5
150 x 75 x 75	(6 x 3 x 3")	AB09G	AB09G/K	5
150 x 100 x 50	(6 x 4 x 2")	AB10G	AB10G/K	5
150 x 100 x 75	(6 x 4 x 3")	AB11G	AB11G/K	5
150 x 150 x 37.5	(6 x 6 x 1.5")	AB12G	AB12G/K	5
150 x 150 x 50	(6 x 6 x 2")	AB13G	AB13G/K	6
150 x 150 x 75	(6 x 6 x 3")	AB14G	AB14G/K	5
150 x 150 x 100	(6 x 6 x 4")	AB15G	AB15G/K	3
225 x 150 x 50	(9 x 6 x 2")	AB16G	AB16G/K	5
225 x 150 x 75	(9 x 6 x 3")	AB17G	AB17G/K	5
225 x 150 x 100	(9 x 6 x 4")	AB18G	AB18G/K	2
225 x 225 x 50	(9 x 9 x 2")	AB19G	AB19G/K	2
225 x 225 x 75	(9 x 9 x 3")	AB20G	AB20G/K	2
225 x 225 x 100	(9 x 9 x 4")	AB21G	AB21G/K	2
300 x 300 x 50	(12 x 12 x 2")	AB22G	AB22G/K	2
300 x 300 x 75	(12 x 12 x 3")	AB23G	AB23G/K	1
300 x 300 x 100	(12 x 12 x 4")	AB24G	AB24G/K	1
300 x 300 x 150	(12 x 12 x 6")	AB25G	AB25G/K	1

IP54 rated (when used in conjunction with rubber gaskets)

Boxes can be supplied plain or with 20mm conduit knockouts on all sides (please see codes above)

\*Available in singles

### IP54 Rated

Our adaptable boxes are certified to IP54 when used in conjunction with Metpro rubber gaskets as detailed on the next page (please refer to our IP chart on page 74 for full details)

Switch & Socket Boxes, Adaptable Boxes & Accessories

## PVC Dry Lining Boxes, PVC Surface Mounted Boxes, Accessories

### Dry Lining Boxes

Size (depth)	No. Gangs	Code	Pack
35mm	1	PDLB1	10
35mm	2	PDLB2	10
47mm	1	PDLB3	10
47mm	2	PDLB4	10

Supplied with 2 x M3.5 brass inserts



### Surface Mounted Boxes

Size (depth)	No. Gangs	Code	Pack
32mm	1	PSB1/C	20
32mm	2	PSB2	10

Supplied with 2 x M3.5 brass inserts  
All boxes have tube and mini-trunking knockouts  
All surface mounted boxes have square corners



### Rubber Gaskets

Size	Code	Pack
75 x 75mm (3 x 3")	SRG33	1
100 x 100mm (4 x 4")	SRG44	1
150 x 150mm (6 x 6")	SRG66	1

Offer an IP54 rating for adaptable boxes when used together



### Raised Countersunk Screws

Size	Code	Pack
M3.5 x 20mm	MH20	100
M3.5 x 25mm	MH25	100
M3.5 x 35mm	MH35	100
M3.5 x 40mm	MH40	100
M3.5 x 50mm	MH50	100
M3.5 x 75mm	MH75	100

Nickel plated finish



Our dry lining boxes and surface mounted boxes are compliant to BS 4607-1:1984 and manufactured in accordance with BSEN61386-1:2008+A1:2019.

We also offer a selection of key accessories for switch & socket, adaptable box and PVC box installations which can be used with the full category range

### PVC Grommets

Size	Type	Code	Pack
20mm	open	GO20	100
25mm	open	GO25	100
32mm	open	GO32	50
38mm	open	GO38	25
50mm	open	GO50	25
20mm	blind	GB20	100
25mm	blind	GB25	100
32mm	blind	GB32	50
38mm	blind	GB38	25
50mm	blind	GB50	25



Designed to prevent cable chafing through trunking and electrical boxes

Ideal for use with switch & socket boxes, adaptable boxes and trunking

### PVC Super Grommets

Size	Type	Code	Pack
20mm	open	GSO20	100
25mm	open	GSO25	100
20mm	blind	GSB20	100
25mm	blind	GSB25	100



Chamfered edge offers fast fix installations

Ideal for use with switch & socket boxes, adaptable boxes and trunking

### Brass Extension Stud

Size	Code	Pack
M3.5	BEXS	100

Nickel plated finish



**Contractor Packs**

*Page 37*

**Glands**

*Pages 37*

**PVC Coated Steel  
Flexible Conduit**

*Pages 38*

**Plain Steel Flexible  
Conduit**

*Pages 38*

**PVC Flexible Conduit**

*Pages 38*

# Flexible Conduit Tube, Contractor Packs & Accessories

*Range accreditations*



Fire Resistant



Self-Extinguishing

Flexible Conduit Tube, Contractor Packs &amp; Accessories

Our flexible conduit range is completed with all the essential items such as IP54 glands and PVC contractor packs for use in a variety of installations

## PVC Contractor Packs, Glands

### PVC Contractor Packs



Size	Code	Pack
20mm	FCCP20	1
25mm	FCCP25	1

#### Supplied in a PVC carry case, each kit contains:

1 x 10mtr coil of PVC flexible conduit | 10 x PVC swivel adaptors

Manufactured from self-extinguishing PVC with black finish

IP40 Rated (please see chart on page 74)

Temp. range -15°C to +60°C

Compression Class 2 (320N)



### Steel Swivel Gland

Size	Code	Pack
20mm	FCSG20N	10
25mm	FCSG25N	10

Manufactured from brass with nickel plated finish  
IP54 rated (please see chart on page 74 for details)



### Steel Fixed Gland

Size	Code	Pack
20mm	FCFG20N	10
25mm	FCFG25N	10

Manufactured from zinc die cast with self colour finish  
IP54 rated (please see chart on page 74 for details)



### PVC Swivel Gland

Size	Code	Pack
20mm	FCSG20P	10
25mm	FCSG25P	10

Manufactured from PVC with black finish  
IP40 rated (please see chart on page 74 for details)

Flexible Conduit Tube, Contractor Packs & Accessories

## PVC Coated Steel, Plain Steel & PVC Flexible Conduit



Our flexible conduit tube offering includes all of the essential products with fire-resistant and self-extinguishing functionality as standard where applicable

### PVC Coated Steel Flexible Conduit

Diameter	Reel Length	Code	Pack
20mm	10mtr	SFC20/10P	1
20mm	25mtr	SFC20/25P	1
20mm	50mtr	SFC20/50P	1
25mm	10mtr	SFC25/10P	1
25mm	25mtr	SFC25/25P	1
25mm	50mtr	SFC25/50P	1

Manufactured from pre-galvanised steel with a black PVC coating finish  
 IP65 rated (please see chart on page 74 for details)  
 Fire resistant to UL94 V0  
 Temperature range -20°C to +80°C

### Plain Steel Flexible Conduit

Diameter	Reel Length	Code	Pack
20mm	10mtr	SFC20/10	1
20mm	25mtr	SFC20/25	1
20mm	50mtr	SFC20/50	1
25mm	10mtr	SFC25/10	1
25mm	25mtr	SFC25/25	1
25mm	50mtr	SFC25/50	1

Manufactured from pre-galvanised steel  
 IP40 rated (please see chart on page 74 for details)  
 Temperature range -50°C to +300°C

### PVC Flexible Conduit

Diameter	Reel Length	Code	Pack
20mm	100mtr	FC20/100	1
25mm	50mtr	FC25/50	1

Manufactured from self-extinguishing PVC  
 IP40 rated (please see chart on page 74 for details)  
 Temperature range -15°C to +60°  
 Compression Class 2 (320N)



Quality control is at the very top of our agenda at Metpro Group, with every stock delivery batch tested in our fully equipped UK laboratory, and in accordance with BS6001-1:1999 to an AQL of 1.5%

Image: Ainis Izkalns, Quality Control Supervisor

**H Frame Kits**

*Page 41*

**Eco-Friendly  
Rubber Feet**

*Pages 41*

**Flat Foot**



Flat Foot



Our brand new Flat Foot range offers ideal mounting solutions for ducting, pipework, cable trays and HVAC installations including our environmentally-friendly Eco Range

H Frame Kit

Size	Code	Pack
305mm	MP305	1
Strut not included		

Offers a quick fix solution for cable management

Ideal for ducting & pipework



Eco Range

Size	Code	Pack
250mm x 180mm	MP250160	1
400mm x 180mm	MP400240	1
600mm x 180mm	MP600450	1
1000mm x 180mm	MP1000645	1

Manufactured from recycled SBR (Styrene-Butadiene Rubber)

Practical & versatile solution for pipework & cable trays

Features 41x21mm 'bonded' built-in channel

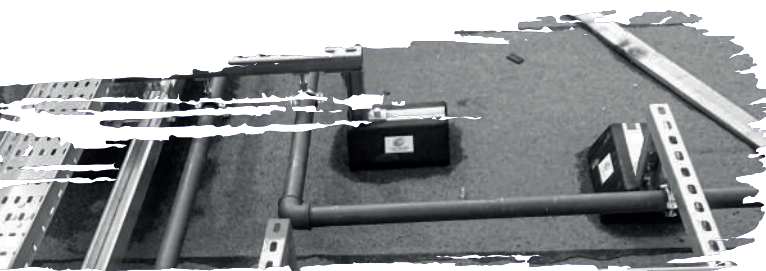

## Conduit Boxes

Pages 43

## Saddles, Bends, Elbows & Tees

Pages 44

## Couplers & Adaptors

Page 44

## Miscellaneous Accessories

Page 45



# PVC Conduit Accessories

Range accreditations



**LSFOH**  
(Low Smoke & Fume,  
Zero Halogen)

PVC Conduit Accessories

## Conduit Boxes

Our PVC conduit boxes are compliant to BS4607-1:1984 and manufactured in accordance with BSEN61386-1:2008+A1:2019, with each box supplied c/w 2 x M4 brass inserts

### Terminal

Size	White	Black	Pack
20mm	PB1W	PB1B	20
25mm	PB11W	PB11B	20



### Intersection

Size	White	Black	Pack
20mm	PB5W	PB5B	20
25mm	PB15W	PB15B	20



### Through

Size	White	Black	Pack
20mm	PB2W	PB2B	20
25mm	PB12W	PB12B	20



### Branch U

Size	White	Black	Pack
20mm	PB6W	PB6B	20



### Angle

Size	White	Black	Pack
20mm	PB3W	PB3B	20
25mm	PB13W	PB13B	20



### Branch Y

Size	White	Black	Pack
20mm	PB7W	PB7B	20



### Tee

Size	White	Black	Pack
20mm	PB4W	PB4B	20
25mm	PB14W	PB14B	20



### H Through

Size	White	Black	Pack
20mm	PB8W	PB8B	20



PVC Conduit Accessories

## Saddles, Bends, Elbows & Tees, Couplers & Adaptors

Our PVC conduit accessories range is compliant to BS4607-1:1984 and manufactured in accordance with BSEN61386-1:2008+A1:2019

### Spacer Bar Saddles

Size	White	Black	Pack
20mm	PSBS20W	PSBS20B	100
25mm	PSBS25W	PSBS25B	100

Comprised of body, strap and c/w 2 x screws



### Inspection Elbow

Size	White	Black	Pack
20mm	PIE20W	PIE20B	20
25mm	PIE25W	PIE25B	20



### Plain Saddles

Size	White	Black	Pack
20mm	PPS20W	PPS20B	100
25mm	PPS25W	PPS25B	100



### Inspection Tee

Size	White	Black	Pack
20mm	PIT20W	PIT20B	20
25mm	PIT25W	PIT25B	20



### Spring Clip Saddles: Round

Size	White	Black	Pack
20mm	PRSC20W	PRSC20B	100
25mm	PRSC25W	PRSC25B	100



### Couplers

Size	White	Black	Pack
20mm	PSC20W	PSC20B	100
25mm	PSC25W	PSC25B	100



### Solid Bend

Size	White	Black	Pack
20mm	PSB20W	PSB20B	20
25mm	PSB25W	PSB25B	20



### Adaptor: Male

Size	White	Black	Pack
20mm	PAM20W	PAM20B	100
25mm	PAM25W	PAM25B	100



### Inspection Bend

Size	White	Black	Pack
20mm	PIB20W	PIB20B	20
25mm	PIB25W	PIB25B	20



### Adaptor: Female

Size	White	Black	Pack
20mm	PAF20W	PAF20B	100
25mm	PAF25W	PAF25B	100



PVC Conduit Accessories

## Miscellaneous Accessories

Our miscellaneous PVC accessories range offers white, black and red finishes where applicable with products compliant to BS4607-1:1984 and manufactured in accordance with BSEN61386-1:2008+A1:2019 (with the exception of adhesive)

### Loop-In Boxes

Size	White	Black	Pack
4 x 20mm knockout	PL4W	PL4B	20

Includes 2 x M4 brass inserts and 4 x 20mm knockouts



### Box Lids/Covers

White	Black	Pack
PLW	PLB	100



### Adhesive

Size	Code	Pack
250ml tin	PAS	1



### Male Bushes: Screwed

Size	White	Black	Pack
20mm	PMB20W	PMB20B	100
25mm	PMB25W	PMB25B	100



### Locknuts



Size	White	Black	Red	Pack
16mm	PLN16W	PLN16B	PLN16R	100
20mm	PLN20W	PLN20B	PLN20R	100
25mm	PLN25W	PLN25B	PLN25R	100
32mm	PLN32W	PLN32B	PLN32R	100

LSOH rating applies to red finish only



### Lock Rings

Size	White	Black	Pack
20mm	PLR20W	PLR20B	100
25mm	PLR25W	PLR25B	100



**Cable Cleats**

*Page 47*

**All Round Band**

*Pages 47*

**Earth Clamps**

*Pages 47*

**Brass Earth Studs**

*Page 47*

**Cable Gland Kits**

*Pages 48*

**Brass TRS Glands**

*Page 48*

**PVC Dome Top  
Glands**

*Pages 49*

**PVC Stuffing Glands**

*Page 49*

**12-Way Strip  
Connectors**

*Pages 49*

**Earth Blocks**

*Pages 49*

**Chapter 52 Range:  
Fire Resistant  
Cable Clips**

*Pages 50*

**Chapter 52 Range:  
Fire Resistant  
Spacer Bar Saddles**

*Pages 51*

# Cable Accessories, Earthing & Wiring Accessories

*Range accreditations*



UK Tested



LUL Authorised



LSFOH  
(Low Smoke & Fume,  
Zero Halogen)



Self-Extinguishing

Cable Accessories, Earthing & Wiring Products

## Miscellaneous Cable Accessories & Earthing & Wiring Products

Our miscellaneous cable / earthing & wiring accessories offering includes a number of essential products for use on a wide variety of electrical installations

### Cable Cleats

Max. Cable Diameter	Code	Pack
10.2mm	C4	100
12.7mm	C5	100
15.2mm	C6	100
17.8mm	C7	100
20.3mm	C8	100
22.8mm	C9	100
25.4mm	C10	100
27.7mm	C11	50
30.4mm	C12	50
35.6mm	C14	50
40.6mm	C16	50
45.7mm	C18	20
50.8mm	C20	20



For clamping & securing armoured cables

High strength & impact resistance

Temperature range -35°C to +85°C

### All Round Band

Size (w)	Galv	Black	Fixing Hole
12mm	ARB12/G	ARB12/B	5mm
17mm	ARB17/G	ARB17/B	7mm



Used to secure cables, pipes, ducts & conduit

Heavy duty, versatile and strong fixing band is easy to cut & bend

Pre-punched fixing holes for bolts or screws

10mtr lengths supplied in a PVC cartridge pack for easy use & waste reduction

Packed in quantities of 1

### PVC Insulation Tape



Colour	Code	Pack
blue	ITBLU	10
black	ITBLK	10
brown	ITBR	10
grey	ITGR	10
green/yellow	ITGY	10
white	ITWH	10
red	ITRE	10
yellow	ITYE	10



All options are 19mm x 33mtr

Manufactured from self-extinguishing, flame retardant PVC and compliant to BSEN60454 & BS3924

### Earth Clamps

Pipe Diameter	Length	Code	Pack
12-32mm	6" (150mm)	EC14	25
50-75mm	12" (300mm)	EC14/L	25



### Brass Earth Stud

Size	Code	Pack
M4	BES	100



Cable Accessories, Earthing & Wiring Products

## Cable Gland Kits, Brass TRS Glands

Our cable gland kits offering includes options for both interior and exterior applications in a variety of sizes with all options compliant to BS6121-1:2005

We also offer Brass TRS glands available in 20mm, 25mm and 32mm sizes

### Cable Gland Kits: BW 20-32mm

Kit Type	Code	Pack
20mm small	BW20S	1
20mm standard	BW20	1
25mm standard	BW25	1
32mm standard	BW32	1



Designed for indoor use, each kit contains:  
2 x glands, 2 x shrouds, 2 x earth tags,  
2 x locknuts

### Cable Gland Kits: BW 40-75mm

Kit Type	Code	Pack
40mm standard	BW40	1
50mm standard	BW50	1
63mm standard	BW63	1
75mm standard	BW75	1



Designed for indoor use, each kit contains:  
1 x gland, 1 x shroud, 1 x earth tag,  
1 x locknut

### Cable Gland Kits: CW 20-32mm

Kit Type	Code	Pack
20mm small	CW20S	1
20mm standard	CW20	1
25mm standard	CW25	1
32mm standard	CW32	1



Designed for outdoor use, each kit contains:  
2 x glands, 2 x shrouds, 2 x earth tags,  
2 x locknuts

### Cable Gland Kits: CW 40-75mm

Kit Type	Code	Pack
40mm standard	CW40	1
50mm standard	CW50	1
63mm standard	CW63	1
75mm standard	CW75	1



Designed for outdoor use, each kit contains:  
1 x gland, 1 x shroud, 1 x earth tag, 1 x locknut

### CABLE GLAND KIT SELECTION CHART

Nominal Conductor Area	Number of Cores											
	1	2	3	4	5	7	10	12	19	27	37	48
1.5	-	20s	20s	20s	20s	20s	20	20	25	25	32	32
2.5	-	20s	20s	20	20	20	25	25	25	32	40	40
4	-	20s	20s	20	20	20	25	25	32	40	40	40
6	-	20	20	20	-	-	-	-	-	-	-	-
10	-	20	25	25	-	-	-	-	-	-	-	-
16	-	25	25	25	-	-	-	-	-	-	-	-
25 Shaped	-	25	25	32	-	-	-	-	-	-	-	-
25 Circular	-	25	32	32	-	-	-	-	-	-	-	-
35 Shaped	-	25	25	32	-	-	-	-	-	-	-	-
35 Circular	-	32	32	40	-	-	-	-	-	-	-	-
50	20	32	32	40	-	-	-	-	-	-	-	-
70	25	32	40	40	-	-	-	-	-	-	-	-
95	25	40	40	50	-	-	-	-	-	-	-	-
120	25	40	50	50	-	-	-	-	-	-	-	-
150	32	40	50	50	-	-	-	-	-	-	-	-
185	32	50	50	63	-	-	-	-	-	-	-	-
240	40	50	63	63	-	-	-	-	-	-	-	-
300	40	63	63	75	-	-	-	-	-	-	-	-
400	50	63	75	75	-	-	-	-	-	-	-	-

### Brass TRS Stuffing Glands

Size	Code	Pack
20mm	BTG1	100
25mm	BTG2	50
32mm	BTG3*	10

\*Can be purchased individually





Cable Accessories, Earthing & Wiring Products

## PVC Glands, Strip Connectors, Earth Blocks

Our PVC glands are designed for use with PVC conduit systems and manufactured in accordance with BSEN61386-1:2008+A1:2019

We also offer polyethylene connector strips and brass earth blocks, ideal for a variety of installations

### PVC Dome Top Glands



Size (cable range)	White	Black	Red	Pack
16mm (5-10mm)	-	PCG16B/510	-	100
20mm (6-12mm)	PCG20W/612	PCG20B/612	PCG20R/612	100
IP68 rated (please see chart on page 74 for details)				
LSOH rating applies to red finish only				



### 12-Way Strip Connectors

Amp Size	Code	Pack
3	CS3A	10
5	CS5A	10
15	CS15A	10
30	CS30A	10
60	CS60A	5
Compliant to BSEN60998-1:2004		



### Earth Blocks

Type	Code	Pack
4 way	EB4	20
8 way	EB8	20



### PVC Stuffing Glands

Size (cable range)	White	Black	Red	Pack
16mm (4-7mm)	PSG16W/248	PSG16B/248	PSG16R/248	100
16mm (7-11mm)	PSG16W/250	PSG16B/250	-	100
20mm (4-7mm)	PSG20W/249	PSG20B/249	PSG20R/249	100
20mm (7-11mm)	PSG20W/251	PSG20B/251	PSG20R/251	100
20mm (8-13mm)	PSG20W/252	PSG20B/252	PSG20R/252	100
25mm (8-13mm)	PSG25W/253	PSG25B/253	PSG25R/253	100
25mm (12-18mm)	PSG25W/254	PSG25B/254	PSG25R/254	100
32mm (18-24mm)	PSG32W/255	PSG32B/255	-	100
IP54 rated (please see chart on page 74 for details)				



Cable Accessories, Earthing & Wiring Products

## Chapter 52 Range: Fire Resistant Cable Clips



Designed for use in PVC trunking, our Chapter 52® Fire Resistant cable clips are compliant to BS7671 and fire rated to BS8434-2

Our cable clips also ensure compliance to BS5839-1: fire detection and fire alarm systems for buildings



### Unique off-centre fixing

Purposefully designed for uneven surfaces, our innovative off-centre fixing slot also allows for easy retrofitting

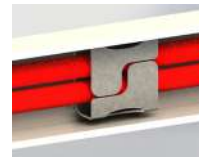

### Easy fold tabs

Designed to retain cables in the event of a fire, our larger sizes, FRC40 & FRC50, also allow for doubling-up of cables offering even greater flexibility



### All trunking sizes catered for

Our fire-resistant cable clips range covers all trunking sizes from mini 25 x 16mm to maxi 50 x 50mm



## UK laboratory tested for complete for 100% confidence

Fire rated to 930oC for 120 minutes, our cable clips exceeded the stringest test requirements of BS8434-2

**(full certification available on request)**

### Fire Resistant Cable Clips



Size	Code	Pack
25 x 16mm trunking	FRC25	100
32 - 40mm trunking base	FRC40	50
46 - 50mm trunking base	FRC50	50

Cable Accessories, Earthing & Wiring Products

## Chapter 52 Range: Fire Resistant Spacer Bar Saddles

Metpro Chapter 52® Fire Resistant spacer bar saddles are manufactured for use with PVC conduit and are compliant to BS7671 and BS8434-2



### Prevents cable collapse

Cables are retained within the saddle strap ensuring safer environments for fire teams and civilians in fire situations

### Colour matched to offer a seamless installation

Our white and black fire-resistant spacer bar saddles receive a surface coating that is colour matched to suit most UK systems, with our range catering for both 20mm & 25mm PVC conduit tube and accessories



## UK laboratory tested for complete for 100% confidence

Fire rated to 930oC for 120 minutes, our spacer bar saddles exceeded the stringest test requirements of BS8434-2

**(full certification available on request)**

### Fire Resistant Spacer Bar Saddles



Size	Colour	Code	Pack
20mm	White	SBS20WH	100
25mm	White	SBS25WH	100
20mm	Black	SBS20BL	100
25mm	Black	SBS25BL	100

### BS 7671: Chapter 52 Amendment

Amendment 3 of BS 7671 Wiring Regulations stipulates that “a suitable fire resistant means of support/retention must be provided to prevent cables falling out in the event of a fire”.

**Hexagon Head Set  
Screws**  
*Page 53*

**Steel Hexagon Nuts**  
*Pages 53*

**Hexagon Nut Caps**  
*Pages 53*

**Top Hat Red Caps**  
*Page 53*

**Steel Wedge Nuts**  
*Pages 53*

**Brass Nuts**  
*Page 53*

**Brass Washers**  
*Pages 54*

**Flat Washers**  
*Pages 54*

**Penny Washers**  
*Pages 54*

**Shakeproof Washers**  
*Pages 54*

**Red Fibre Washers**  
*Pages 54*

**Single Coil Spring  
Washers**  
*Pages 54*

**Non-Drill Anchors  
& Setting Tools**  
*Pages 54*

**Roofing Bolts  
& Square Nuts**  
*Pages 54*

## **Fixings & Fasteners**

Fixings & Fasteners

Our general fixings range offers all the essentials needed for most mechanical & electrical installations

## General Fixings & Fasteners

### Hexagon Head Set Screws: HT8.8

mm>>	16mm	20mm	25mm	30mm	35mm	40mm	50mm	60mm	80mm	100mm
M6	HH616	HH620	HH625	HH630	HH635	HH640	HH650	-	-	-
M8	HH816	HH820	HH825	HH830	HH835	HH840	HH850	-	-	-
M10	-	HH1020	HH1025	HH1030	HH1035	HH1040	HH1050	HH1060	HH1080	HH10100
M12	-	HH1220	HH1225	HH1230	HH1235	HH1240	HH1250	HH1260	HH1280	HH12100



Manufactured from high tensile steel Grade 8.8

Packed in quantities of 100

M16 and M20 available on request

BZP finish

### Steel Hexagon Nuts: Grade 8

Size	Code	Pack
M6	HFN6	100
M8	HFN8	100
M10	HFN10	100
M12	HFN12	100



M16 & M20 available on request

BZP finish

### Steel Wedge Nuts

Size	Code	Pack
M6	WN6	100
M8	WN8	100
M10	WN10	100
M12	WN12	100



BZP finish

### Hexagon Nut Caps

Size	White	Black	Pack
M6	HNC6/W	HNC6/B	100
M8	HNC8/W	HNC8/B	100
M10	HNC10/W	HNC10/B	100
M12	HNC12/W	HNC12/B	100



### Brass Nuts

Size	Code	Pack
M4	BMN	100



### Top Hat Rod Caps

Size	White	Black	Pack
M8	RC8TH/W	RC8TH/B	100
M10	RC10TH/W	RC10TH/B	100
M12	RC12TH/W	RC12TH/B	100



### Brass Washers

Size	Code	Pack
M4	BMW	100



Fixings & Fasteners

## General Fixings & Fasteners (continued)

We stock a variety of washer options to offer the most appropriate solution for the job

Our roofing bolts offering covers all standard sizes with each bolt supplied c/w M6 flat nut

### Washers: Flat

Size	Code	Pack
M6	FW6	100
M8	FW8	100
M10	FW10	100
M12	FW12	100

BZP finish



### Washers: Single Coil Spring

Size	Code	Pack
M6	SCSWM6	100
M8	SCSWM8	100
M10	SCSWM10	100

Produced to DIN 127B



### Washers: Penny

Size	Code	Pack
M6	PW6	100
M8	PW8	100
M10	PW10	100
M12	PW12	100

25mm outer diameter  
BZP finish



### Non-Drill Anchors & Setting Tools

Size	Code	Pack
M6 anchor	NDA6	100
M8 anchor	NDA8	100
M10 anchor	NDA10	100
M12 anchor	NDA12	50
M6 tool	NDA6/ST	1
M8 tool	NDA8/ST	1
M10 tool	NDA10/ST	1
M12 tool	NDA12/ST	1

BZP finish



### Washers: Shakeproof

Size	Code	Pack
M6	SW6	100
M8	SW8	100
M10	SW10	100
M12	SW12	100
M16	SW16	100
M20	SW20	100
M25	SW25	100
M32	SW32	50

BZP finish



### Roofing Bolts & Square Nuts

Size	Code	Pack
M6 x 12mm	RB612	200
M6 x 16mm	RB616	200
M6 x 20mm	RB620	200
M6 x 25mm	RB625	200
M6 x 30mm	RB630	200
M6 x 35mm	RB635	100
M6 x 40mm	RB640	100
M6 x 50mm	RB650	100
flat roofing nut	FN6	100

Each roofing bolt is supplied c/w M6 flat nut  
BZP finish



### Washers: Red Fibre

Size	Code	Pack
M20	RFW20	100
M25	RFW25	100
M32	RFW32	50

Self-colour finish





In addition to our manufacturing capabilities, we also offer a powder coating service, all carried out in line with your exact requirements, with product coated to meet the desired RAL colour

# DEMON CATO

A metpro Group Brand

## INNOVATIONS FOR THE BUILT ENVIRONMENT

**Beginning operations in 2008, Demon Cato was devised to understand, address and ultimately answer the call for innovation within the construction industry.**

The first product introduction was the hugely successful Conlok system, now a staple product used in large scale commercial and infrastructure projects such as; Heathrow Terminal 2, the Sir Chris Hoy Velodrome and the new Tottenham Hotspur Football Club stadium.

Our innovations are solely designed for the contractor and are still supplied exclusively through our network of approved distributors and stockists.

As well as typically offering significant labour savings, our products also provide key on-site health & safety benefits including reduced manual handling and SKU consolidation (where applicable).

Demon Cato became a Metpro brand in July 2021. With Metpro's 25 years of manufacturing experience and operating from a 61,000 square feet distribution centre, the acquisition of Demon Cato was a natural extension of the existing product offer. This brand has also enabled us to enhance our manufacturing capabilities as the legacy Metpro service to OEM customers now falls under the Demon Cato banner. More information on our bespoke manufacturing service can be found on page 68.

## OUR INNOVATIONS

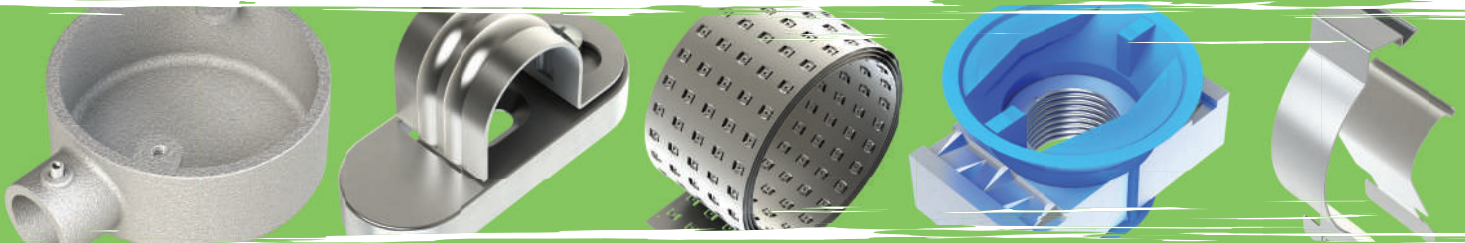

{ CONLOK  
STEEL CONDUIT SYSTEM }

{ RAPID  
SADDLE }

{ ROLLATRAY }

{ EASYFIT  
CHANNEL NUTS }

{ TRUN(KLIP)  
TRAY(KLIP) }



# Innovation & Excellence — in Manufacturing —

## OUR MANUFACTURING CAPABILITIES

### Casting



#### Why Casting?

Highly customisable part design  
Reduced material wastage  
High volumes easily catered for

#### Our casting options:

Investment | Gravity Die | Low Pressure |  
High Pressure | Centrifugal | Continuous |  
Sand

### Turning & Milling



#### Why Turning & Milling?

Perfect for where precision is needed  
Ideal for working with other processes  
Relatively shorter lead times

#### Our turning & milling options:

Traditional | Multi-Axis CNC | Gear Cutting |  
Broaching | Cylindrical & Surface | Grinding

### Forging



#### Why Forging?

Truly bespoke outer profiles  
Ideal for mechanical strength  
High volumes easily catered for

#### Our forging options:

Open Die/Hand | Impression Die | Press |  
Upset | Roll | Net Shape & Near-Net Shape

### Pressing & Stamping



#### Why Pressing & Stamping?

Parts manufactured from plate metal  
Ideal for thinner material gauges  
High volumes easily catered for

#### Our pressing & stamping options:

Press Brake Machine | Laser Cutting |  
Progressive Punch Machine |  
Rolling Press Machine | Punch Machine

### Injection Moulding

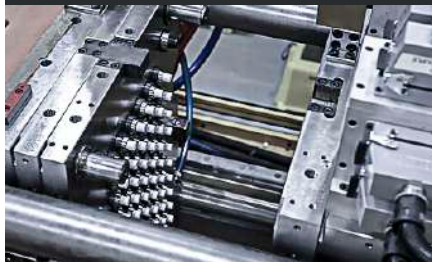

#### Why Injection Moulding?

Ideally suited to plastic-based materials  
High volumes easily catered for

#### Our injection moulding options:

High & Low Pressure | Blow | Compression |  
Film Insert | Gas Assist | Rotational | Foam |  
Vacuum Forming | Extrusion |  
Powder Metallurgy

### Bespoke Manufacturing



#### Why work with Demon Cato?

Reduce your working capital  
Full turnkey solutions tailored to you  
Access to our global manufacturing base

**Want to find out more about our bespoke  
manufacturing service and capabilities?**

# CONLOK®

## STEEL CONDUIT SYSTEM



A unique new product designed to dramatically increase installation speeds and reduce downtime in a wide variety of installations.

### Key features & benefits



**No need to thread tube**  
With Conlok®'s unique built-in grub screw



**Fast-fix solution**  
Ideal for major projects where cost & safety are critical

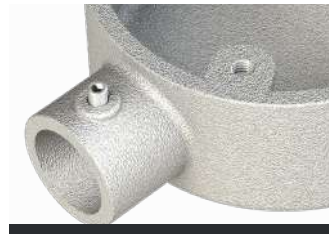

**Fully galvanized system**  
Offering greater corrosion resistance



**Full range of accessories**  
Offering all the essential items for quick installations

### Where you can find Conlok®

**Tottenham Hotspur  
FC Stadium,**  
London



**Sir Chris Hoy  
Velodrome,**  
Glasgow



**Midland Metropolitan  
Hospital,**  
West Midlands



**Tees Rep Biomass  
Power Station,**  
Glasgow



### How it works



 { INSERT }



 { SECURE }



 { DONE }

 Increased on-site safety

 Compliant to the latest standards

 Reduced on-site storage

 Used on major UK projects

## Conlok® Class 4 HDG System

Demon Cato Code	Product Description	TSI Code	Box Qty
CLGCEXTERNAL20	20mm x 3mtr Class 4 HDG	434174353	1
CLGCEXTERNAL25	25mm x 3mtr Class 4 HDG	434174366	1
CL1G	20mm Terminal Box	391797257	10
CL2G	20mm Through Box	391797338	10
CL3G	20mm Angle Box	391797354	10
CL4G	20mm Tee Box	391797367	10
CL5G	20mm Intersection Box	391797396	10
CL6G	20mm Branch U Box	391797406	10
CL7G	20mm Branch Y Box	391797419	10
CL8G	25mm Terminal Box	391797422	10
CL9G	25mm Through Box	391797435	10
CL10G	25mm Angle Box	391797448	10
CL11G	25mm Tee Box	391797451	10
CL12G	25mm Intersection Box	391797464	10
CL13G	25mm Branch U Box	391797477	10
CL14G	25mm Branch Y Box	391797480	10
CL15G	25mm Terminal Box c/w 25mm Hole in Base	391797516	10
CL16G	20mm Back Outlet Box c/w screw	391797529	10
CL20FC	20mm Female Coupler	391797558	25
CL25FC	25mm Female Coupler	391797561	25
CL20GA	20mm Adaptor	391797590	40
CL25GA	25mm Adaptor	391797600	30
CL20GC	20mm Solid Coupler	391797532	40
CL25GC	25mm Solid Coupler	391797545	30
CL20MB	20mm Solid Bend	391797613	20
CL25MB	25mm Solid Bend	391797626	10
CLKEY	Conlok Allen Key	391797639	1
CLKIT	Conlok Allen Key c/w 2 x Grub Screws	425711327	1

## Conlok® Clean Room System

Demon Cato Code	Product Description	TSI Code	Box Qty
CLGCCLEAN20	20mm x 3mtr Clean Room	434655843	1
CLGCCLEAN25	25mm x 3tr Clean Room	434655856	1
CL1GCLEAN	20mm Terminal Box	434164101	10
CL2GCLEAN	20mm Through Box	434164114	10
CL3GCLEAN	20mm Angle Box	434164127	10
CL4GCLEAN	20mm Tee Box	434164130	10
CL5GCLEAN	20mm Intersection Box	434163908	10
CL6GCLEAN	20mm Branch U Box	434163911	10
CL7GCLEAN	20mm Branch Y Box	434163924	10
CL8GCLEAN	25mm Terminal Box	434163937	10
CL9GCLEAN	25mm Through Box	434163940	10
CL10GCLEAN	25mm Angle Box	434163953	10
CL11GCLEAN	25mm Tee Box	434163966	10
CL12GCLEAN	25mm Intersection Box	434163979	10
CL13GCLEAN	25mm Branch U Box	434163982	10
CL14GCLEAN	25mm Branch Y Box	434163995	10
CL15GCLEAN	25mm Terminal Box c/w 25mm Hole in Base	434164004	10
CL16GCLEAN	20mm Back Outlet Box	434164017	10
CL20FCCLEAN	20mm Female Coupler	434164088	25
CL25FCCLEAN	25mm Female Coupler	434164091	25
CL20GACLEAN	20mm Adaptor	434164046	40
CL25GACLEAN	25mm Adaptor	434164059	30
CL20GCCLEAN	20mm Solid Coupler	434164020	40
CL25GCCLEAN	25mm Solid Coupler	434164033	30
CL20MBCLEAN	20mm Solid Bend	434164062	20
CL25MBCLEAN	25mm Solid Bend	434164075	10

# RAPID SADDLE



An innovative new saddle designed to increase installation speeds and increase safety when working at height.

## Key features & benefits



**Finishes for all environments**  
Delta Protekt® | BZP |  
Clean Room



**Greater on-site safety**  
No dropped screws or straps,  
ideal for working at height



**Holds conduit tube in situ.**  
Making installations simple,  
even for a single installer



**Single screw fixing**  
Locate the saddle strap &  
quarter turn to secure

## Where you can find Rapid Saddle®

**Major Regeneration  
Project,  
Bristol**



**Beacon College,  
Hereford**



## How it works



{ FIX }



{ INSERT }



{ SECURE }

  
Increased  
on-site safety

  
Salt spray tested  
to 500+ hours\*  
\*Delta Protekt option only

  
Reduced on-site  
storage

  
Conceived &  
designed in-house

## External Rapid Saddle®

Demon Cato Code	Product Description	TSI Code	Box Qty
RAPID20EXTERNAL	20mm Rapid Saddle Delta Protekt® 120	425711398	100
RAPID25EXTERNAL	25mm Rapid Saddle Delta Protekt® 120	425711152	100

## Internal Rapid Saddle®

Demon Cato Code	Product Description	TSI Code	Box Qty
RAPID20INTERNAL	20mm Rapid Saddle BZP	425711398	100
RAPID25INTERNAL	25mm Rapid Saddle BZP	425711152	100

## Clean Room Rapid Saddle®

Demon Cato Code	Product Description	TSI Code	Box Qty
RAPID20CLEAN	20mm Rapid Saddle Clean Room	425711398	100
RAPID25CLEAN	25mm Rapid Saddle Clean Room	425711152	100



A unique new product designed to dramatically increase installation speeds and reduce downtime in underfloor applications.

## Key features & benefits



**No couplers or brackets**  
Easily installed anywhere with a solid surface



**15 seconds for full roll out**  
Available in 3 widths; 150mm, 300mm, 450mm

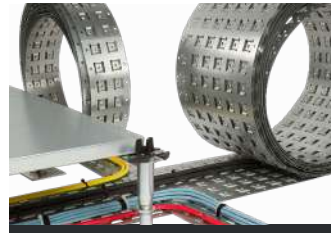

**Flexible fixing arrangement**  
With Rollatray's innovative raised nipples & snail thread



**Simple bends, tees & 4-ways**  
Crossover Rollatray units & secure with an M6 screw

## Where you can find Rollatray®

Olympic Park  
Redevelopment,  
London



Major Data Centre, Dublin

Skypark Fit Out, Glasgow

## How it works



  
Increased on-site safety

  
Compliant to the latest standards

  
Reduced on-site storage

  
Accepts a wide range of cable ties

Sometimes, **speed is everything.**

**Rollatray®**

Demon Cato Code	Product Description	TSI Code	Box Qty
RT150	150mm x 15mtr Rollatray	408810122	1
RT300	300mm x 15mtr Rollatray	408810135	1
RT450	450mm x 15mtr Rollatray	408810148	1
RTCUTTER	Rollatray Guillotine	434560242	1

**Rollatray® weights & handling recommendations**



Weight per coil:

Recommended handling:

Weight per coil:

Recommended handling:

Weight per coil:

Recommended handling:

**11.7kg**



**23.2kg**



..... or .....



**34.9g**



..... or .....



# TRUNK **KLIP**® & TRAY **KLIP**®



Trunkclip® & Trayclip® offer a brand new and much quicker solution for securing steel channel to trunking and cable tray.

## Key features & benefits



**Secures trunking & tray**  
Quickly & efficiently every time



**Greater on-site safety**  
No need for drills or spring nuts,  
just locate & *klip*



**Innovative H-frame design**  
Product sits within channel for  
easy positioning



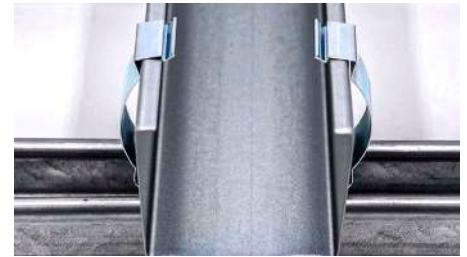

**Clean & tidy finish**  
Trunkclip allows for trunking lids  
to be fixed securely

## How it works



  
Increased  
on-site safety

  
Work with most  
major brands

  
Reduced on-site  
storage

  
Sizes to suit all  
installations

## NEW PRODUCT *for* 2024



No drills, bolts or nuts; **makes sense.**

**Trunklip®**

Demon Cato Code	Product Description	TSI Code	Box Qty
TK2K	2" Trunklip	435985376	50
TK3K	3" Trunklip	435985389	50
TK4K	4" Trunklip	435985392	50

**Trayklip™**

Demon Cato Code	Product Description	TSI Code	Box Qty
MCTMK	Medium Return Trayklip	435985402	100
MCTHK	Heavy Return Trayklip	435985363	100

# EASYFIT CHANNEL NUTS

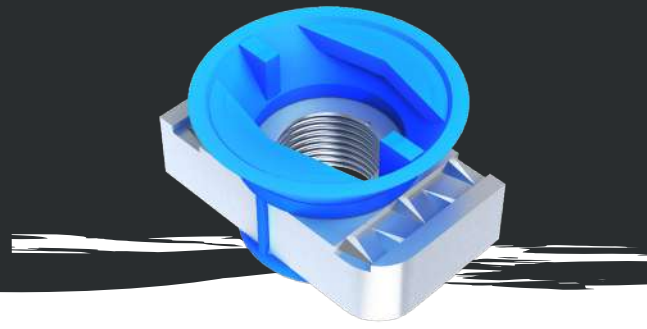

A unique steel channel nut designed to offer faster, safer installations.

## Key features & benefits



**One-handed installations**  
Built-in finger grips designed for simple installations



**Slide & hold design**  
Easyfit's nylon jacket allows for easy positioning

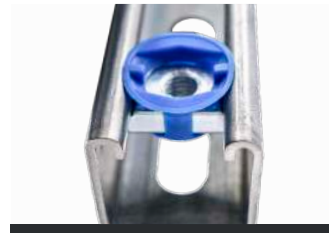

**No springs to untangle**  
Enhancing on-site safety, especially when at height





**Compliant to BS6946:1988**  
In line with standard channel nuts

## How it works



  
Increased  
on-site safety

  
Sizes to suit  
all strut depths

  
Reduced on-site  
storage

  
Design-registered  
innovation

# Channel nuts, **with a twist.**

## Easyfit Channel Nuts

Demon Cato Code	Product Description	TSI Code	Box Qty
EF6	M6 Easyfit Channel Nut	436011346	100
EF8	M8 Easyfit Channel Nut	436011359	100
EF10	M10 Easyfit Channel Nut	436011362	100
EF12	M12 Easyfit Channel Nut	436011375	100

## Discover Metpro



### London Underground (LUL) Authorised

We're proud to have LUL authorisation across our core product ranges (where applicable) in accordance with LU Standard 1-085 (for use on surface & sub-surface locations)



### Building Information Modelling (BIM)

We offer the necessary Revit® files for use in Building Information Modelling across our full standard products portfolio



### In-house Quality Control

Manufactured to the relevant British Standards where applicable, all Metpro stock is inspected in accordance with BS6001-1:1999 to an AQL of 1.5%



**100+ years**  
in-house  
knowledge



**Global**  
supplier  
base



**We work**  
to fit your  
needs



**Technical**  
product  
support



**Rapid**  
prototyping  
capabilities



**Our team**  
are always  
here to help

---

## How we deliver



**Get in touch**  
We're available from 8:30am to 5pm Monday to Friday using the following information:  
Call **0121 552 2100**  
Email **sales@metpro.co.uk**  
Live chat **metpro.co.uk**



**Customer Commitment**  
We supply exclusively through Metpro stockists and electrical wholesalers as part of our ongoing support of the industry



**Central Location**  
We operate from our 50,000sq/ft distribution centre in the West Midlands, just off junction one of the M5



**Accurate & Prompt Delivery\***  
**Standard delivery:** orders despatched for arrival within 2-3 business days (up to 5 days for conduit tube).  
\*min. order value applies



**Next day delivery\*\*** is available if required and please specify this on your Purchase Order or to one of our team.  
\*\*next day carriage charges may apply



**Collection** from our distribution centre is also available within 1 hour of order placement.

## Our Online Service Offer



### Why use this service?

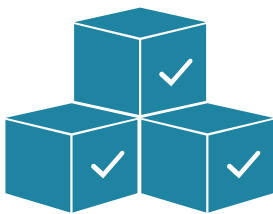

#### Live stock levels

Easily find products, see live stock levels, place your orders online and see your order updates from placement to delivery.



#### Your bespoke pricing

Access your account for bespoke pricing, order history, total spend and other key information with just a few clicks.

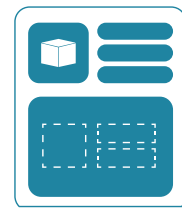

#### Technical information

Download essential documents including data sheets and BIM files for your customers through our dedicated Knowledge Centre.

### Looking to setup your Metpro Online account?

Simply contact our team and we'll have you up and running within 24 hours.

[www.metpro.co.uk](http://www.metpro.co.uk)

## Quality, at every stage

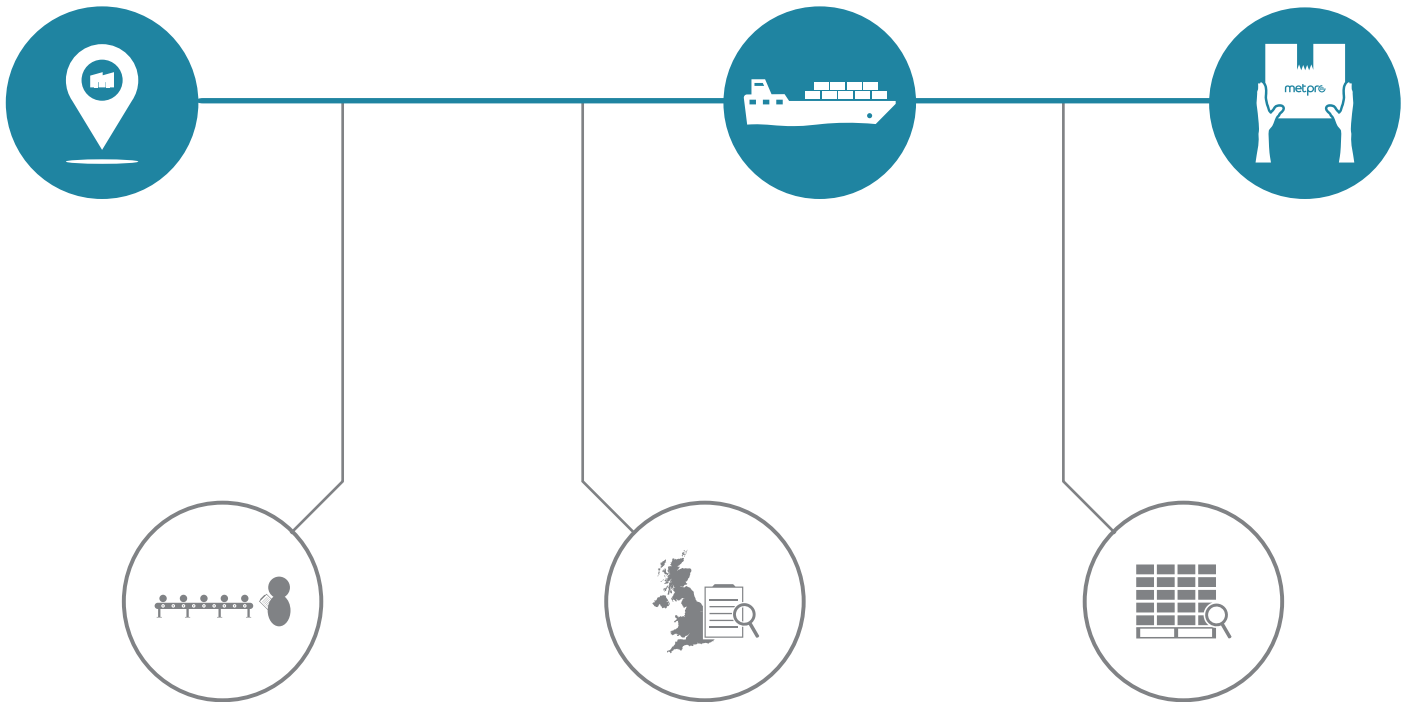

### Quality inspection in country

We directly employ qualified engineers overseas who carry out ongoing inspections during batch production of all Metpro stock. Our on-site employees also ensure that all Metpro partner factories are operating ethically and in accordance with the latest global standards.

### First UK quality inspection

Following the production of bulk stock, our on-site engineers produce a quality report with their recommendation on whether product should be shipped. Our UK quality team review this report and it is their final decision as to whether product is suitable for shipment.

### Final UK quality inspection

Upon receipt of stock to our UK distribution centre, all products receive a batch inspection in accordance with BS6001-1:1999 to an AQL of 1.5%. Our aim at Metpro across the full product portfolio is to ensure all stock maintains the quality standards our national & international customers expect.

## Our Quality Equipment

All Metpro quality equipment is UKAS calibrated where applicable.



### XRF Analyser

Designed to confirm material specifications & RoHS compliance



### 6 Axis Faro Gauge Arm

Portable 3D coordinate measurement system with a working range of 1.2m and measurement accuracy of 0.018mm



### Swift Microscope

Microscopic vision system designed to ensure maximum accuracy with the touch of a finger



### Load Testing Facility

Our bespoke load testing apparatus allows us to carry out ongoing internal tests on Metpro load-bearing products, offering continued confidence at all levels of construction



### Manual Gauges

Vernier Calipers | Depth Gauges | Height Gauge | Gloss Meter

### The future:

#### Continued investment

In order to continually improve our service offering and ensure we are always up-to-date, we continue to invest in the latest technologies, ensuring our product standards are never compromised.

For more information about our quality control operation or for a tour of our facility, please contact us and we would be very happy to welcome you to Metpro Group.

## Major Projects

Since 1995, we are proud to have been involved with a number of high profile major projects.

Metpro product is currently in use across a variety of sectors, including infrastructure, aerospace, retail and higher education.

We have provided a small selection of key projects we have been involved with here and would welcome any request for further information.



### Aerospace

- Heathrow Airport
- Gatwick Airport
- Edinburgh Airport
- Bristol Airport

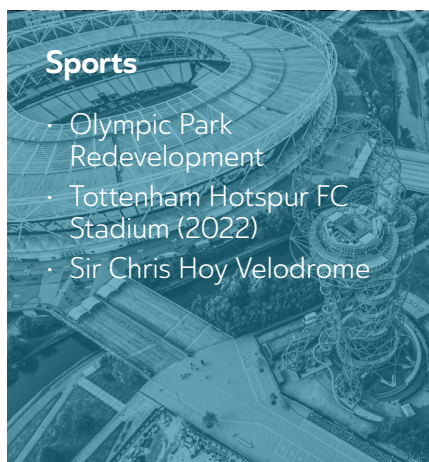

### Sports

- Olympic Park Redevelopment
- Tottenham Hotspur FC Stadium (2022)
- Sir Chris Hoy Velodrome

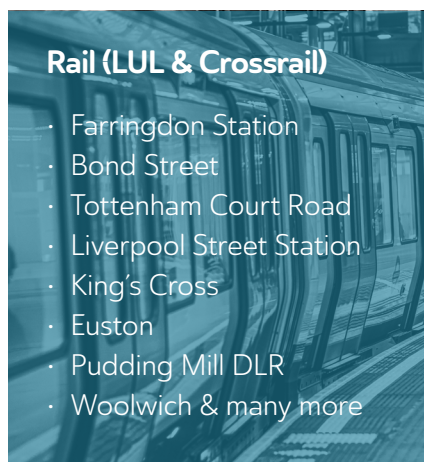

### Rail (LUL & Crossrail)

- Farringdon Station
- Bond Street
- Tottenham Court Road
- Liverpool Street Station
- King's Cross
- Euston
- Pudding Mill DLR
- Woolwich & many more

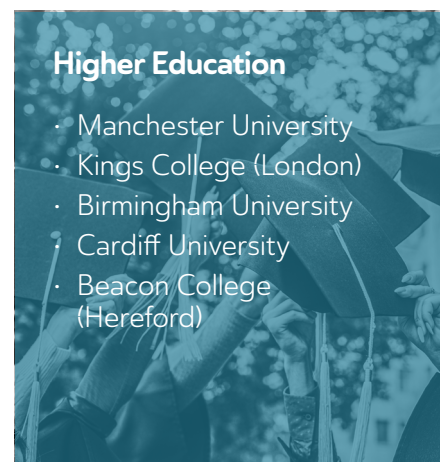

### Higher Education

- Manchester University
- Kings College (London)
- Birmingham University
- Cardiff University
- Beacon College (Hereford)

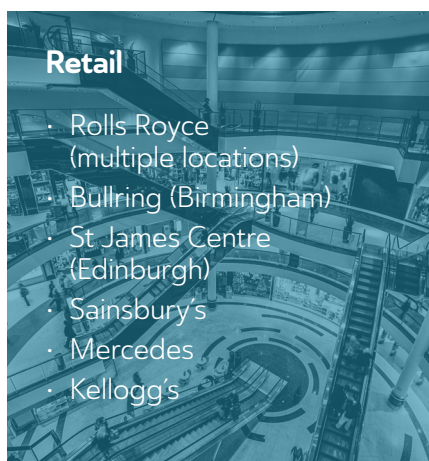

### Retail

- Rolls Royce (multiple locations)
- Bullring (Birmingham)
- St James Centre (Edinburgh)
- Sainsbury's
- Mercedes
- Kellogg's



### Healthcare

- Midland Metropolitan Hospital
- Alder Hey National Hospital for Children



### Government

- Ministry of Defence Bicester (Oxfordshire)
- Kendrew Barracks (Oakham)
- Multiple HMP sites including; Aberdeen, Bedford, and Addiewell



## Discover more about Metpro



### Reducing our Carbon Footprint

At Metpro, we recognise the importance of our environment and our responsibility to play a part in the protection of this.

Having joined with Smart Carbon in December of 2021, Metpro Group have gathered the necessary data to understand our carbon footprint, with all our Scope 1 & 2 emissions now offset for years 2019, 2020, 2021., and 2022. However, we realise that we can do more and are now committed to not only reducing our carbon output, but also offsetting our entire operation and achieving total carbon neutrality by mid-2025.

Get in touch to find out more or follow our journey on Metpro Online or social media.



### Industry Involvement

We are proud to further our support of the electro-mechanical industry through our affiliate membership with the Electrical Distributors Association (EDA).

Enabling Metpro to play a part in key discussions as well as gain a greater understanding of the industry's needs, we look forward to working with colleagues at all stages of construction as we seek to find better, safer and more efficient products & working practices to enhance both the present and future of this pivotal UK sector.



### Operating Transparently

Ensuring Metpro quality is not limited to our products, we are certified to ISO9001:2015, the leading UK Quality Management System.



Designed to streamline internal processes and improve internal communications amongst other benefits, operating with this system means we are always running as efficiently as possible and that Metpro's goals are clear for all staff.

TECHNICAL SECTION

# Ingress Protection (IP) Chart

Ingress Protection or IP classifies varying degrees of protection for products with an IP rating provided following testing as detailed below

## First digit: Protection against solids

**1** Protected against solids greater than 50mm  
Example: a hand



**2** Protected against solids greater than 12.5mm  
Example: a finger



**3** Protected against solids greater than 2.5mm  
Example: a screwdriver



**4** Protected against solids greater than 1mm  
Example: a wire



**5** Protected against dust with limited, non-harmful ingress permitted



**6** Completely protected against dust with no ingress permitted



## Second digit: Protection against liquids

**1** Protected against vertically falling water drops with limited ingress permitted



**2** Protected against vertically falling water drops with enclosure tilted up to 15°, limited ingress permitted



**3** Protected against water sprays up to 60° from the vertical, limited ingress permitted



**4** Protected against water splash from all directions with limited ingress permitted



**5** Protected against water jets with limited ingress permitted



**6** Protected against powerful water jets with limited ingress permitted



**7** Completely watertight against immersion effects in water between 15cm and 1m for 30 minutes



**8** Completely watertight against immersion effects in water under pressure for long time periods



## Metpro IP Rated Products Index

Product	IP	Page
Adaptable boxes*	IP54	34
PVC flexible conduit: contractor packs	IP40	37
Flexible metal conduit adaptor: swivel	IP54	37
Flexible metal conduit adaptor: fixed	IP54	37
PVC coated steel flexible conduit	IP65	38
Steel flexible conduit	IP40	38
PVC flexible conduit	IP40	38
PVC dome top glands	IP68	49
PVC stuffing glands	IP54	49

\*when used in conjunction with rubber gaskets (page 35)

TECHNICAL SECTION

## British Standards, RoHS Statement, CE & UKCA Markings

Where applicable, our products are manufactured to comply with British Standards and in accordance with RoHS 2 to provide our customers with full confidence in Metpro products

### Metpro British Standards Index

British Standard	Standard Title	Metpro Related Product(s)	Page
BSEN61386-1:2008+A1:2019	Conduit Systems for Cable Management: General Requirements	Class 4 steel conduit tube, malleable conduit boxes, steel conduit accessories PVC conduit boxes & accessories	07-17, 43-45
BS6946:1998	Specification for Metal Channel Cable Support Systems for Electrical Installations	Easyfit channel nut & channel spring nuts (nut only), bracketry, switch & socket boxes	21-30, 33
BS4662:2006	Boxes for Flush Mounting of Electrical Accessories	Switch & socket boxes, extension boxes	33
BSEN60454:2007	Pressure-sensitive adhesive tapes for electrical purposes	PVC insulation tape	47
BSEN60998-1:2004	Connecting Devices for Low Voltage Circuits for Household and Similar Purposes	12 way polyethylene strip connectors	49
BS7671:2018	Requirements for Electrical Installations: IET Wiring Regulations	Metpro Chapter 52® range	50-51
BS8434-2:2003 + A2:2009	Methods of Test for Assessment of the Fire Integrity of Electrical Cables	Metpro Chapter 52® range	50-51
BS5839-1:2017	Fire Detection and Fire Alarm Systems for Buildings: Code of Practice for Design, Installation, Commissioning and Maintenance of Systems in Non-Domestic Premises	Metpro fire-resistant cable clips	50

#### RoHS Statement

We confirm that all Metpro products are responsibly manufactured and where applicable comply to the requirements of RoHS 2 as detailed in the Restriction of Hazardous Substances (RoHS) Directive 2015.

If you would like any further information regarding RoHS 2 please contact our sales team on 0121 552 2100 or email [sales@metpro.co.uk](mailto:sales@metpro.co.uk)

#### CE & UKCA Markings

Where possible and required, Metpro products are CE and UKCA marked or we are able to supply Certificates of Conformity to confirm this. If you require any such documentation, please do not hesitate to contact our team who would be happy to help.

# Terms & Conditions

## The customer's attention is drawn in particular to the provisions of clause 9

### 1. Interpretation

- 1.1 Definitions. In these conditions, the following definitions apply:-  
 "Business Day" a day (other than a Saturday, Sunday or public holiday) when banks in London are open for business.  
 "Conditions" the terms and conditions set out in this document as amended from time to time in accordance with clause 11.6.  
 "Contract" the contract between the Supplier and the Customer for the sale and purchase of the Goods in accordance with these Conditions.  
 "Customer" the person or firm who purchases the Goods from the Supplier  
 "Force Majeure Event" has the meaning given in clause 10.  
 "Goods" the goods (or any part of them) set out in the Order.  
 "Order" the Customer's order for the Goods, as set out in the Customer's purchase order form, the Customer's written acceptance of the Supplier's quotation, or overleaf, as the case may be.  
 "Specification" any specification for the Goods, including any related plans and drawings, that is supplied to the Supplier by the Customer, or produced by the Supplier and agreed in writing by the Customer.  
 "Supplier" Metpro Limited (registered in England and Wales with company number 2849037).

### 1.2 Construction. In these Conditions, the following rules apply:

- 1.2.1. A person includes a natural person, corporate or unincorporated body (whether or not having separate legal personality).
- 1.2.2. A reference to a party includes its personal representatives, successors or permitted assigns.
- 1.2.3. A reference to a statute or statutory provision is a reference to such statute or provision as amended or re-enacted. A reference to a statute or statutory provision includes any subordinate legislation made under that statute or statutory provision, as amended or re-enacted.
- 1.2.4. Any phrase introduced by the terms including, include, in particular or any similar expression shall be construed as illustrative and shall not limit the sense of the words preceding those terms.
- 1.2.5. A reference to writing or written includes faxes.

### 2. Basis of contract

- 2.1 These Conditions apply to the Contract to the exclusion of any other terms that the Customer seeks to impose or incorporate, or which are implied by trade, custom, practice or course of dealing.
- 2.2 The Order constitutes an offer by the Customer to purchase the Goods in accordance with these Conditions. The Customer shall ensure that the terms of the Order and any relevant Specification are complete and accurate.
- 2.3 The Order shall only be deemed to be accepted when the Supplier issues a written acceptance of the Order or if earlier, when the Supplier delivers the Goods, at which point the Contract shall come into existence. The Contract constitutes the entire agreement between the parties. The Customer acknowledges that it has not relied on any statement, promise or representation made or given by or on behalf of the Supplier which is not set out in the Contract. Any samples, drawings, descriptive matter, or advertising issued by the Supplier and any descriptions or illustrations contained in the Supplier's catalogues or brochures are issued or published for the sole purpose of giving an approximate idea of the Goods described in them. They shall not form part of the Contract or any other contract between the Supplier and the Customer for the sale of the Goods.
- 2.5 A quotation for the Goods given by the Supplier shall not constitute an offer. A quotation shall only be valid for a period of 20 Business Days from its date of issue.

### 3. Delivery

- 3.1 The Supplier shall ensure that:  
 3.1.1. each delivery of the Goods is accompanied by a delivery note which shows the date of the Order, all relevant Customer and Supplier reference numbers, the type and quantity of the Goods (including the code number of the Goods, where applicable), special storage instructions (if any) and, if the Order is being delivered by instalments, the outstanding balance of Goods remaining to be delivered; and  
 3.1.2. if the Supplier requires the Customer to return any packaging materials to the Supplier, that fact is clearly stated on the delivery note. The Customer shall make any such packaging materials available for collection at such times as the Supplier shall reasonably request. Returns of packaging materials shall be at the Supplier's expense.
- 3.3 The Supplier shall deliver the Goods to the location set out in the Order or such other location as the parties may agree (Delivery Location) at any time after the Supplier notifies the Customer that the Goods are ready.
- 3.4 Delivery of the Goods shall be completed on the completion of loading of the Goods at the Delivery Location. Any dates quoted for delivery are approximate only, and the time of delivery is not of the essence. The Supplier shall not be liable for any delay in delivery of the Goods that is caused by a Force Majeure event or the Customer's failure to provide the Supplier with adequate delivery instructions or any other instructions that are relevant to the supply of the Goods.  
 If the Supplier fails to deliver the Goods, its liability shall be limited to the costs and expenses incurred by the Customer in obtaining replacement goods of similar description and quality in the cheapest market available, less the price of the Goods. The Supplier shall have no liability for any failure to deliver the Goods to the extent that such failure is caused by a Force Majeure Event or the Customer's failure to provide the Supplier with adequate delivery instructions or any other instructions that are relevant to the supply of the Goods.
- 3.6 If the Delivery Location is anywhere other than the Supplier's premises and any of the Goods become lost damaged during the delivery to the Delivery Location, the Supplier's total liability to the Customer in respect of such loss of damaged Goods shall not exceed the higher of the price of the Goods or the amount actually recovered from the third party that delivered the Goods to the Delivery Location on behalf of the Supplier.

- 3.7 If the Customer fails to accept delivery of the Goods within 3 Business Days of the Supplier notifying the Customer that the Goods are ready, then, except where such failure or delay is caused by a Force Majeure Event or the Supplier's failure to comply with its obligations under the Contract:  
 3.7.1. delivery of the Goods shall be deemed to have been completed at 9.00 am on the third Business Day following the day on which the Supplier notified the Customer that the Goods were ready; and  
 3.7.2. the Supplier shall store the Goods until delivery takes place, and charge the Customer for all related costs and expenses (including insurance).
- 3.8 If 10 Business Days after the Supplier notified the Customer that the Goods were ready for delivery the Customer has not accepted delivery of them, the Supplier may resell or otherwise dispose of part or all of the Goods and, after deducting reasonable storage and selling costs, account to the Customer for any excess over the price of the Goods or charge the Customer for any shortfall below the price of the Goods.
- 3.9 The Customer shall not be entitled to reject the Goods if the Supplier delivers up to and including 5% more or less than the quantity of Goods ordered, but a pro rata adjustment shall be made to the Order invoice on receipt of notice from the Customer that the wrong quantity of Goods was delivered.
- 3.10 The Supplier may deliver the Goods by instalments, which shall be invoiced and paid for separately. Each instalment shall constitute a separate Contract. Any delay in delivery or defect in an instalment shall not entitle the Customer to cancel any other instalment.
- 3.11 Any claims for shortage, non-delivery or Goods damaged during transit must be notified to the Supplier within 3 Business Days of the date of delivery (in the case of shortage or Goods damaged in transit) or the anticipated date of delivery (in the case of non-delivery).

### 4. Quality

- 4.1 The Supplier warrants that on delivery, and for a period of 12 months from the date of delivery (warranty period), the Goods shall:  
 4.1.1. conform in all material respects with their description and any applicable Specification; and  
 4.1.2. be free from material defects in design, material and workmanship.
- 4.2 Subject to clause 4.3, if:  
 4.2.1. the Customer gives notice in writing to the Supplier during the warranty period within a reasonable time of discovery that some or all of the Goods do not comply with the warranty set out in clause 4.1, and  
 4.2.2. the Supplier is given a reasonable opportunity of examining such Goods; and  
 4.2.3. the Customer (if asked to do so by the Supplier) returns such Goods to the Supplier's place of business at the Customer's cost, the Supplier shall, at its option, repair or replace the defective Goods, or refund the price of the defective Goods and the cost of their return in full.
- 4.3 The Supplier shall not be liable for Goods' failure to comply with the warranty set out in clause 4.1 if:  
 4.3.1. the Customer makes any further use of such Goods after giving notice in accordance with clause 4.2; or  
 4.3.2. the defect arises because the Customer failed to follow the Supplier's oral or written instructions as to the storage, commissioning, installation, use and maintenance of the Goods or (if there are none) good trade practice; or  
 4.3.3. the defect arises as a result of the Supplier following any drawing, design or specification supplied by the Customer; or  
 4.3.4. the Customer alters or repairs such Goods without the written consent of the Supplier; or  
 4.3.5. the defect arises as a result of fair wear and tear, wilful damage, negligence, or abnormal storage or working conditions.
- 4.4 Except as provided in this clause 4, the Supplier shall have no liability to the Customer in respect of the Goods' failure to comply with the warranty set out in clause 4.1.
- 4.5 Except as set out in these Conditions, all warranties, conditions and other terms implied by statute or common law are, to the fullest extent permitted by law, excluded from the Contract.
- 4.6 These Conditions shall apply to any repaired or replacement Goods supplied by the Supplier.

### 5. Title and risk

- 5.1 The risk in the Goods shall pass to the Customer on completion of delivery.
- 5.2 Title to the Goods shall not pass to the Customer until the Supplier has received payment in full (in cash or cleared funds) for:  
 5.2.1. the Goods; and  
 5.2.2. all other sums which are or which become due to the Supplier for sales of the Goods or any other products to the Customer.
- 5.3 Until title to the Goods has passed to the Customer, the Customer shall:  
 5.3.1. hold the Goods on a fiduciary basis as the Supplier's bailee;  
 5.3.2. store the Goods separately from all other goods held by the Customer so that they remain readily identifiable as the Supplier's property;  
 5.3.3. not remove, deface or obscure any identifying mark or packaging on or relating to the Goods;  
 5.3.4. maintain the Goods in satisfactory condition and keep them insured against all risks for their full price from the date of delivery;  
 5.3.5. notify the Supplier immediately if it becomes subject to any of the events listed in clause 8.2; and  
 5.3.6. give the Supplier such information relating to the Goods as the Supplier may require from time to time, but the Customer may resell or use the Goods in the ordinary course of its business.
- 5.4 If before title to the Goods passes to the Customer the Customer becomes subject to any of the events listed in clause 8.2, or the Supplier reasonably believes that any such event is about to happen and notifies the Customer accordingly, then, provided that the Goods have not been resold, or irrevocably incorporated into another product, and without limiting any other right or remedy the Supplier may have, the Supplier may at any time require the Customer to deliver up the Goods and, if the Customer fails to do so promptly, enter any premises of the Customer or of any third party where the Goods are stored in order to recover them.

# Terms & Conditions

## 6. Price and payment

- 6.1 The price of the Goods shall be the price set out in the Order, or, if no price is quoted, the price set out in the Supplier's published price list in force as at the date of delivery.
- 6.2 The Supplier may, by giving notice to the Customer at any time up to 20 Business Days before delivery, increase the price of the Goods to reflect any increase in the cost of the Goods that is due to:
  - 6.2.1 any factor beyond the Supplier's control (including foreign exchange fluctuations, increases in taxes and duties, and increases in labour, materials and other manufacturing costs);
  - 6.2.2 any request by the Customer to change the delivery date(s), quantities or types of Goods ordered, or the Specification; or
  - 6.2.3 any delay caused by any instructions of the Customer or failure of the Customer to give the Supplier adequate or accurate information or instructions.
- 6.3 The price of the Goods is exclusive of the costs and charges of packaging, insurance and transport of the Goods, which shall be paid by the Customer when it pays for the Goods.
- 6.4 The price of the Goods is exclusive of amounts in respect of value added tax (VAT). The Customer shall, on receipt of a valid VAT invoice from the Supplier, pay to the Supplier such additional amounts in respect of VAT as are chargeable on the supply of the Goods.
- 6.5 The Supplier may invoice the Customer for the Goods on or at any time after the completion of delivery.
- 6.6 Unless otherwise agreed by the Supplier in writing, the Customer shall pay the invoice in full and in cleared funds by the end of the month following the month the invoice was dated. Payment shall be made to the bank account nominated in writing by the Supplier. Time of payment is of the essence.
- 6.7 If the Customer fails to make any payment due to the Supplier under the Contract by the due date for payment (due date), then the Customer shall pay interest on the overdue amount at the rate of 4% per annum above The Royal Bank of Scotland Plc's base lending rate from time to time. Such interest shall accrue on a daily basis from the due date until the date of actual payment of the overdue amount, whether before or after judgment. The Customer shall pay the interest together with the overdue amount.
- 6.8 The Customer shall pay all amounts due under the Contract in full without any deduction or withholding except as required by law and the Customer shall not be entitled to assert any credit, set-off or counterclaim against the Supplier in order to justify withholding payment of any such amount in whole or in part. The Supplier may at any time, without limiting any other rights or remedies it may have, set off any amount owing to it by the Customer against any amount payable by the Supplier to the Customer.

## 7. Cancellation

- 7.1 The Customer shall not cancel an Order without the prior consent of the Supplier.
- 7.2 Upon cancellation, the Customer shall pay to the Supplier all of the Supplier's outstanding unpaid invoices and interest together with a reasonable sum (determined by the Supplier) in respect of the Supplier's work in progress.

## 8. Customer's insolvency or incapacity

- 8.1 If the Customer becomes subject to any of the events listed in clause 8.2, or the Supplier reasonably believes that the Customer is about to become subject to any of them and notifies the Customer accordingly, then, without limiting any other right or remedy available to the Supplier, the Supplier may cancel or suspend all further deliveries under the Contract or under any other contract between the Customer and the Supplier without incurring any liability to the Customer, and all outstanding sums in respect of Goods delivered to the Customer shall become immediately due.
- 8.2 For the purposes of clause 8.1, the relevant events are:
  - 8.2.1 the Customer suspends, or threatens to suspend, payment of its debts or is unable to pay its debts as they fall due or admits inability to pay its debts or (being a company) is deemed unable to pay its debts within the meaning of section 123 of the Insolvency Act 1986, or (being an individual) is deemed either unable to pay its debts or as having no reasonable prospect of so doing, in either case, within the meaning of section 268 of the Insolvency Act 1986, or (being a partnership) has any partner to whom any of the foregoing apply; or
  - 8.2.2 the Customer commences negotiations with all or any class of its creditors with a view to rescheduling any of its debts, or makes a proposal for or enters into any compromise or arrangement with its creditors; or
  - 8.2.3 (being an individual) the Customer is the subject of a bankruptcy petition or order; or
  - 8.2.4 a creditor or encumbrancer of the Customer attaches or takes possession of, or a distress, execution, sequestration or other such process is levied or enforced on or sued against, the whole or any part of its assets and such attachment or process is not discharged within 14 days; or
  - 8.2.5 (being a company) an application is made to court, or an order is made, for the appointment of an administrator or if a notice of intention to appoint an administrator is given or if an administrator is appointed over the Customer; or
  - 8.2.6 (being a company) a floating charge holder over the assets of the Customer has become entitled to appoint or has appointed an administrative receiver; or
  - 8.2.7 a person becomes entitled to appoint a receiver over the assets of the Customer or a receiver is appointed over the assets of the Customer; or
  - 8.2.8 any event occurs, or proceeding is taken, with respect to the Customer in any jurisdiction to which it is subject that has an effect equivalent or similar to any of the events mentioned in clause 8.2.1 to clause 8.2.7 (inclusive); or
  - 8.2.9 the Customer suspends, threatens to suspend, ceases or threatens to cease to carry on all or substantially the whole of its business; or
  - 8.2.10 the financial position of the Supplier deteriorates to such an extent that in the opinion of the Customer the capability of the Seller adequately to fulfil its obligations under the Contract has been placed in jeopardy.
  - 8.2.11 (being an individual) the Customer dies or, by reason of illness or incapacity (whether mental or physical), is incapable of managing his or her own affairs or becomes a patient under any mental health legislation.

## 9. Limitation of liability

- 9.1 Nothing in these Conditions shall limit or exclude the Supplier's liability for:
  - 9.1.1 death or personal injury caused by its negligence, or the negligence of its employees, agents or subcontractors (as applicable);
  - 9.1.2 fraud or fraudulent misrepresentation; or
  - 9.1.3 breach of the terms implied by section 12 of the Sale of Goods Act 1979; or
  - 9.1.4 defective products under the Consumer Protection Act 1987; or
  - 9.1.5 any matter in respect of which it would be unlawful for the Supplier to exclude or restrict liability.
- 9.2 Subject to clause 9.1:
  - 9.2.1 the Supplier shall not be liable to the Customer, whether in contract, tort (including negligence), breach of statutory duty, or otherwise, for any loss of profit or indirect or consequential loss arising under or in connection with the Contract (including any losses that may result from a deliberate breach of the Contract by the Supplier, its employees, agents or subcontractors); and
  - 9.2.2 subject to clause 3.6, the Supplier's total liability to the Customer in respect of all other losses arising under or in connection with the Contract, whether in contract, tort (including negligence), breach of statutory duty, or otherwise, including losses caused by a deliberate personal or deliberate breach of the Contract by the Supplier, its employees, agents or subcontractors shall not exceed the higher of the price of the Goods or the amount actually recovered from the Supplier's insurance company.
- 9.3 Subject to clause 9.1, the Supplier shall have no liability to the Customer for shortage, non-delivery or Goods damaged during transit unless the Customer has notified the Supplier of the claim in accordance with clause 3.11.

## 10. Force majeure

Neither party shall be liable for any failure or delay in performing its obligations under the Contract to the extent that such failure or delay is caused by a Force Majeure Event. A Force Majeure Event means any event beyond a party's reasonable control, which by its nature could not have been foreseen, or, if it could have been foreseen, was unavoidable, including strikes, lock-outs or other industrial disputes (whether involving its own workforce or a third party's), failure of energy sources or transport network, acts of God, war, terrorism, riot, civil commotion, interference by civil or military authorities, national or international calamity, armed conflict, malicious damage, breakdown of plant or machinery, nuclear, chemical or biological contamination, sonic boom, explosions, collapse of building structures, fires, floods, storms, earthquakes, loss at sea, epidemics or similar events, natural disasters or extreme adverse weather conditions, or default of suppliers or subcontractors.

## 11.

### 11.1

#### General

- Assignment and subcontracting
  - 11.1.1 The Supplier may at any time assign, transfer, charge, subcontract or deal in any other manner with all or any of its rights or obligations under the Contract.
  - 11.1.2 The Customer may not assign, transfer, charge, subcontract or deal in any other manner with all or any of its rights or obligations under the Contract without the prior written consent of the Supplier.
- 11.2 Notices
  - 11.2.1 Any notice or other communication given to a party under or in connection with the Contract shall be in writing, addressed to that party at its registered office (if it is a company) or its principal place of business (in any other case) or such other address as that party may have specified to the other party in writing in accordance with this clause, and shall be delivered personally, sent by pre-paid first-class post, recorded delivery, commercial courier, fax.
  - 11.2.2 A notice or other communication shall be deemed to have been received: if delivered personally, when left at the address referred to in clause 11.2.1; if sent by pre-paid first-class post or recorded delivery, at 9.00 am on the second Business Day after posting; if delivered by commercial courier, on the date and at the time that the courier's delivery receipt is signed; or, if sent by fax, one Business Day after transmission.
  - 11.2.3 The provisions of this clause shall not apply to the service of any proceedings or other documents in any legal action.
- 11.3 Severance
  - 11.3.1 If any court or competent authority finds that any provision of the Contract (or part of any provision) is invalid, illegal or unenforceable, that provision or part-provision shall, to the extent required, be deemed to be deleted, and the validity and enforceability of the other provisions of the Contract shall not be affected.
  - 11.3.2 If any invalid, unenforceable or illegal provision of the Contract would be valid, enforceable and legal if some part of it were deleted, the provision shall apply with the minimum modification necessary to make it legal, valid and enforceable.
- 11.4 Waiver. A waiver of any right or remedy under the Contract is only effective if given in writing and shall not be deemed a waiver of any subsequent breach or default. No failure or delay by a party to exercise any right or remedy provided under the Contract or by law shall constitute a waiver of that or any other right or remedy, nor shall it preclude or restrict the further exercise of that or any other right or remedy. No single or partial exercise of such right or remedy shall preclude or restrict the further exercise of that or any other right or remedy.
- 11.5 Third party rights. A person who is not a party to the Contract shall not have any rights under or in connection with it.
- 11.6 Any variation to the Contract, including the introduction of any additional terms and conditions, shall only be binding when agreed in writing and signed by the Customer.
- Governing law and jurisdiction. The Contract, and any dispute or claim arising out of or in connection with it or its subject matter or formation (including non-contractual disputes or claims), shall be governed by, and construed in accordance with, English law, and the parties irrevocably submit to the exclusive jurisdiction of the courts of England and Wales.



Well laid out computer-linked stocks allow for timely & accurate deliveries

Image: Metpro warehouse



TS

TS

TS

NO. TS  
QTY. 800 PCS

D61 C18

D63 C18

D65

GROSS WEIGHT: 7.34 kg  
NET WEIGHT: 7.74 kg  
METPRO ORDER NO. 80884

GROSS WEIGHT: 7.34 kg  
NET WEIGHT: 7.74 kg  
METPRO ORDER NO. 80884

93808

923808

79



**Metpro Ltd**

Unit 4 Summit Crescent  
Smethwick  
West Midlands  
United Kingdom  
B66 1BT

📞 +44 (0) 121 552 2100

✉️ sales@metpro.co.uk

📠 +44 (0) 121 552 3363

🌐 metpro.co.uk

🌐 metpro ltd

📘 @metpro ltd

📷 @metpro ltd

---

**Quality products**

*for the Built Environment*